

Fabbian

NEWS

2017.2

<https://www.lustrograd.com/vendors/fabbian/>



COMPANY PROFILE

Fabbian Illuminazione was established in 1961 as a company manufacturing lighting appliances for residential and commercial purposes. The longstanding tradition and expertise made it possible to conceive lighting fixtures of high quality, both in terms of design and materials. The success path of the company allowed Fabbian to grow internationally and establish itself as a leading brand in the lighting industry. Great results have been achieved through continuous research aimed at interpreting the market demand, while implementing specific marketing and advertising strategies.

The company is based in the North East of Italy, where all collections are conceived, developed and manufactured. Thanks to the collaboration with renowned architects and designers and a technologically advanced production plant, all products have their own distinctive design.

Fabbian markets its product through a well-established network of agents and retailers in Europe, Middle East and Asia. Whereas in the American market, Fabbian reaches its customers through an affiliate company based in New York.

Fabbian Illuminazione si costituisce nel 1961 quale azienda produttrice di lampade per l'habitat e il contract. Questa cultura unitamente alla tradizione e alla qualità si è sempre espressa nella valenza del prodotto, consentendo all'azienda di acquisire progressivamente riconoscimento e dimensione internazionali. I risultati scaturiscono dalle esperienze di continue ricerche, tese sempre ad interpretare al meglio le esigenze dei mercati, elaborando precise politiche e strategie di marketing.

L'azienda ha sede in Italia e qui produce tutte le sue collezioni, interpreta con personalità le nuove tendenze del moderno design attraverso una molteplicità di stili, utilizzando tecnologie produttive all'avanguardia ed avvalendosi di un folto gruppo di designers internazionali.

Fabbian commercializza i suoi prodotti attraverso una rete consolidata di agenti e rivenditori in Europa, in Medio Oriente e in Asia. Nel mercato americano, Fabbian raggiunge i suoi clienti attraverso una società affiliata con sede a New York.

INDEX

	Aérostat	p. 2-9
	Beluga Royal	p. 12-13
NEW!	Claque	p. 14-19
	Crio	p. 20-21
NEW!	Freeline	p. 22-25
	Giunco	p. 26-29
	Laminis	p. 30-31
NEW!	Lens	p. 32-35
	Metropole	p. 36-37
NEW!	Olympic	p. 38-39
	Tripla	p. 40-47

AÉROSTAT

Guillaume Delvigne



AÉROSTAT

Guillaume Delvigne

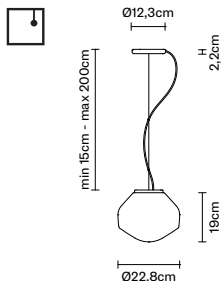

code

electrification

technical info

accessories

F27 A01
01 White

LED 220-240V
1x8.7W-120°
WHITE 3000K
800lm Cri >80



EAC IP20
0,027 m³
2,18 kg

INCLUDED:
- LED / LED
- Kit per decentramento / Off-center
cable fastener

Dimmerabile TRIAC / Dimmable TRIAC

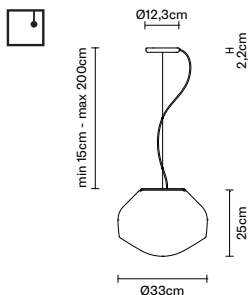

F27 A02
01 White

E27 220-240V
1x150W HSGST



E27 220-240V
1x15W FBG



EAC IP20
0,071 m³
3,89 kg

INCLUDED:
- Kit per decentramento / Off-center
cable fastener

NOT INCLUDED:
- Lampadina / Bulb

F27 A03
01 White

LED 220-240V
1x17W-120°
WHITE 3000K
1850lm Cri >80



EAC IP20
0,071 m³
5,36 kg

INCLUDED:
- LED / LED
- Kit per decentramento / Off-center
cable fastener

Dimmerabile TRIAC / Dimmable TRIAC

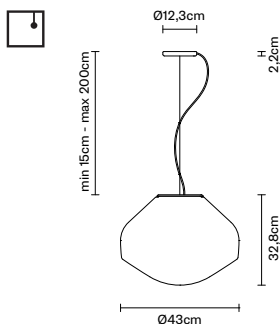

F27 A04
01 White

E27 220-240V
1x205W HSGST



E27 220-240V
1x15W FBG



EAC IP20
0,122 m³
4,74 kg

INCLUDED:
- Kit per decentramento / Off-center
cable fastener

NOT INCLUDED:
- Lampadina / Bulb

F27 A05
01 White

LED 220-240V
1x17W-120°
WHITE 3000K
1850lm Cri >80



EAC IP20
0,122 m³
5,27 kg

INCLUDED:
- LED / LED
- Kit per decentramento / Off-center
cable fastener

Dimmerabile TRIAC / Dimmable TRIAC



AÉROSTAT

Guillaume Delvigne

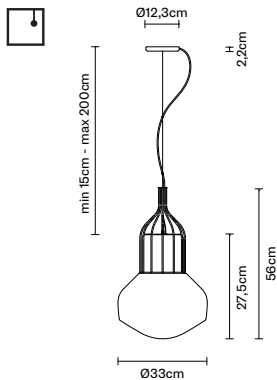

code

electrification

technical info

accessories

F27 A11

19 Brass-plated
24 Black chrome
41 Copper

E27 220-240V
1x150W HSGST

EAC IP20

NOT INCLUDED:
- Lampadina / Bulb



E27 220-240V
1x15W FBG

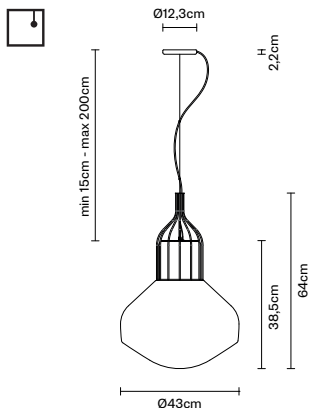

F27 A13

19 Brass-plated
24 Black chrome
41 Copper

E27 220-240V
1x150W HSGST

EAC IP20

NOT INCLUDED:
- Lampadina / Bulb



E27 220-240V
1x30W FBT





AÉROSTAT

Guillaume Delvigne

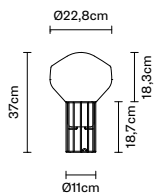

code

electrification

technical info

accessories

F27 B01

19 Brass-plated
24 Black chrome
41 Copper

E14 220-240V
1x46W HSGSB



E14 220-240V
1x11W FBT



EAC



IP20

0,027 m³
2,27 kg

NOT INCLUDED:
- Lampadina / Bulb

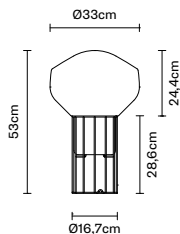

F27 B03

19 Brass-plated
24 Black chrome
41 Copper

E27 220-240V
1x150W HSGST



E27 220-240V
1x30W FBT



EAC



IP20

0,106 m³
5,57 kg

NOT INCLUDED:
- Lampadina / Bulb





AÉROSTAT

Guillaume Delvigne

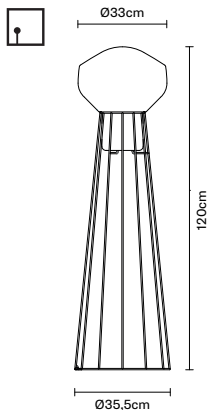

code

electrification

technical info

accessories

F27 C01

19 Brass-plated

24 Black chrome

41 Copper

E27 220-240V
1x150W HSGST



EAC  **IP20**

NOT INCLUDED:
- Lampadina / Bulb

.....
E27 220-240V
1x15W FBG

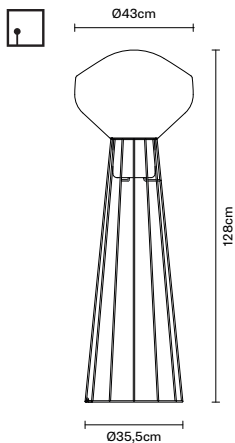

F27 C03

19 Brass-plated

24 Black chrome

41 Copper

E27 220-240V
1x150W HSGST



EAC  **IP20**

NOT INCLUDED:
- Lampadina / Bulb

.....
E27 220-240V
1x30W FBT





AÉROSTAT

Guillaume Delvigne

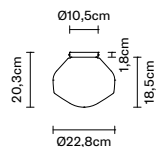

code

electrification

technical info

accessories

F27 G01
01 White

LED 220-240V
1x8.7W-120°
WHITE 3000K
800lm Cri >80



EAC IP40
0,027 m³
1,60 kg

INCLUDED:
- LED / LED

Dimmerabile TRIAC / Dimmable TRIAC

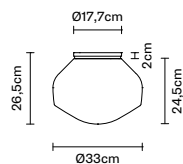

F27 G07
01 White

E27 220-240V
1x150W HSGST



EAC IP40
0,071 m³
2,51 kg

NOT INCLUDED:
- Lampadina / Bulb

E27 220-240V
1x15W FBG



F27 G03
01 White

LED 220-240V
1x17W-120°
WHITE 3000K
1850lm Cri >80



EAC IP40
0,071 m³
3,86 kg

INCLUDED:
- LED / LED

Dimmerabile TRIAC / Dimmable TRIAC

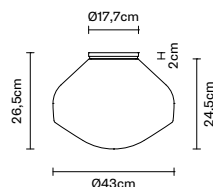

F27 G09
01 White

E27 220-240V
1x150W HSGST



EAC IP40
0,122 m³
6,04 kg

NOT INCLUDED:
- Lampadina / Bulb

E27 220-240V
1x30W FBT



F27 G05
01 White

LED 220-240V
1x17W-120°
WHITE 3000K
1850lm Cri >80



EAC IP40
0,122 m³
4,13 kg

INCLUDED:
- LED / LED

Dimmerabile TRIAC / Dimmable TRIAC

BELUGA ROYAL

Marc Sadler

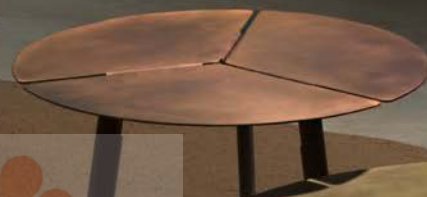

BELUGA ROYAL

Marc Sadler

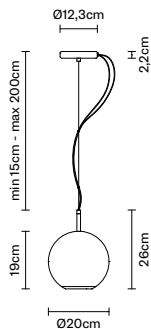

code

electrification

technical info

accessories

D57 A51

12 Gold
34 Titanium
41 Bronze

LED 220-240V
1x8.7W-120°
WHITE 3000K
800lm CRI >80



EAC IP40

0,027 m³
2,18 kg



INCLUDED:

- LED / LED
- Kit per decentramento / Off-center
cable fastener

Dimmerabile TRIAC / Dimmable TRIAC

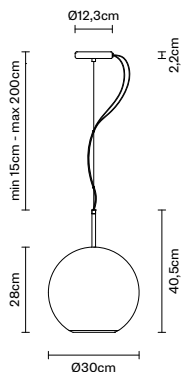

D57 A53

12 Gold
34 Titanium
41 Bronze

LED 220-240V
1x17W-120°
WHITE 3000K
1850lm CRI >80



EAC IP40

0,071 m³
5,36 kg



INCLUDED:

- LED / LED
- Kit per decentramento / Off-center
cable fastener

Dimmerabile TRIAC / Dimmable TRIAC

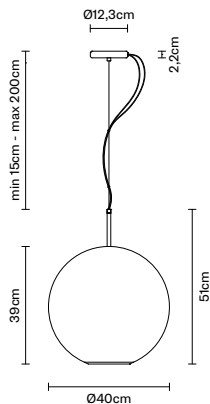

D57 A55

12 Gold
34 Titanium
41 Bronze

LED 220-240V
1x17W-120°
WHITE 3000K
1850lm CRI >80



EAC IP40

0,122 m³
5,27 kg



INCLUDED:

- LED / LED
- Kit per decentramento / Off-center
cable fastener

Dimmerabile TRIAC / Dimmable TRIAC

CLAQUE

Marc Sadler



CLAQUE

Marc Sadler

code

electrification

technical info

accessories

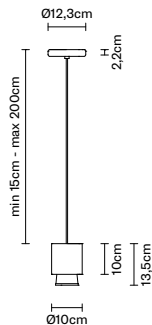

NEW! **F43 A01**
02 Black

LED 220-240V
1x20W-34°
WHITE 3000K
2000lm Cri 90

EAC IP40

INCLUDED:
- LED / LED

Dimmerabile TRIAC / Dimmable TRIAC

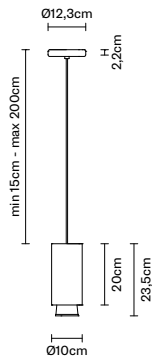

NEW! **F43 A03**
02 Black

LED 220-240V
1x20W-34°
WHITE 3000K
2000lm Cri 90

EAC IP40

INCLUDED:
- LED / LED

Dimmerabile TRIAC / Dimmable TRIAC

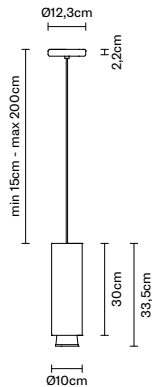

NEW! **F43 A05**
02 Black

LED 220-240V
1x20W-34°
WHITE 3000K
2000lm Cri 90

EAC IP40

INCLUDED:
- LED / LED

Dimmerabile TRIAC / Dimmable TRIAC



CLAQUE

Marc Sadler

code

electrification

technical info

accessories

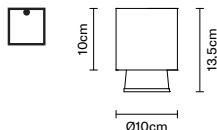

NEW! **F43 E01**
02 Black

LED 220-240V
1x20W-34°
WHITE 3000K
2000lm Cri 90

EAC IP40

INCLUDED:
- LED / LED

Dimmerabile TRIAC / Dimmable TRIAC

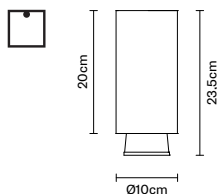

NEW! **F43 E03**
02 Black

LED 220-240V
1x20W-34°
WHITE 3000K
2000lm Cri 90

EAC IP40

INCLUDED:
- LED / LED

Dimmerabile TRIAC / Dimmable TRIAC

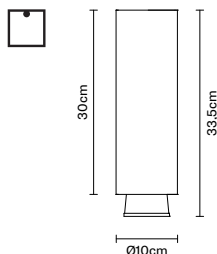

NEW! **F43 E05**
02 Black

LED 220-240V
1x20W-34°
WHITE 3000K
2000lm Cri 90

EAC IP40

INCLUDED:
- LED / LED

Dimmerabile TRIAC / Dimmable TRIAC

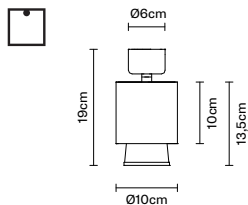

NEW! **F43 E07**
02 Black

LED 220-240V
1x20W-34°
WHITE 3000K
2000lm Cri 90

EAC IP40 360° ADJUSTABLE SYSTEM

INCLUDED:
- LED / LED

Dimmerabile TRIAC / Dimmable TRIAC



CLAQUE

Marc Sadler

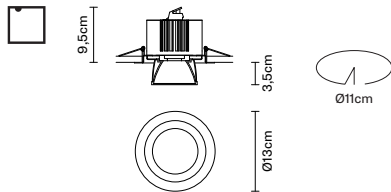

code

electrification

technical info

accessories

NEW! **F43 F01**
02 Black

LED 220-240V
1x20W-34°
WHITE 3000K
2000lm Cri 90



EAC IP40



INCLUDED:
- LED / LED

Dimmerabile TRIAC / Dimmable TRIAC

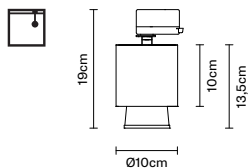

NEW! **F43 J01**
02 Black

LED 220-240V
1x20W-34°
WHITE 3000K
2000lm Cri 90



EAC IP40



INCLUDED:
- LED / LED

Dimmerabile TRIAC / Dimmable TRIAC



CRIO

—
Gio Minelli



CRIO

Gio Minelli

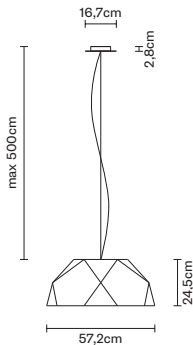

code

electrification

technical info

accessories

D81 A01

01 White

48 Dark wood colour

69 Light wood colour

E27 220-240V
5x18W FBT



EACIP20

0,176 m³
9,37 kg

NOT INCLUDED:
- Lampadina / Bulb

D81 A09

01 White

48 Dark wood colour

69 Light wood colour

LED 220-240V
3x17.5W-120°
WHITE 3000K
6150lm CRI >80



EACIP20

0,176 m³
9,37 kg

INCLUDED:
- LED / LED
- Alimentatore elettronico dimmerabile /
Dimmable electronic driver

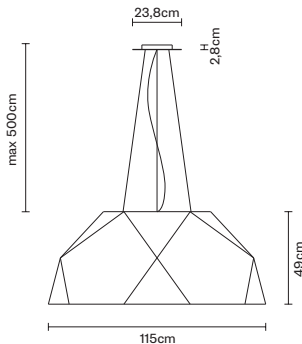

D81 A03

01 White

48 Dark wood colour

69 Light wood colour

E27 220-240V
10x22W FBT



EACIP20

1 m³
28,67 kg

NOT INCLUDED:
- Lampadina / Bulb

D81 A13

01 White

48 Dark wood colour

69 Light wood colour

LED 220-240V
5x27.8W-120°
WHITE 3000K
16650lm CRI >80



EACIP20

1 m³
28,67 kg

INCLUDED:
- LED / LED
- Alimentatore elettronico dimmerabile /
Dimmable electronic driver

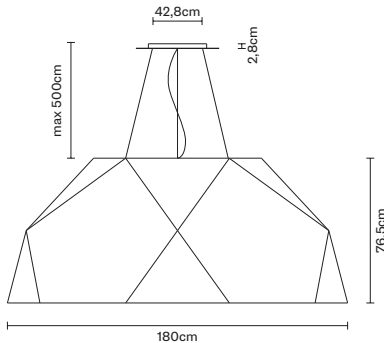

D81 A17

01 White

48 Dark wood colour

69 Light wood colour

LED 220-240V
6x27.8W-120°
WHITE 3000K
19980lm CRI >80



EACIP20

1 m³
28,67 kg

INCLUDED:
- LED / LED
- Alimentatore elettronico dimmerabile /
Dimmable electronic driver



FREELINE

Flynn Talbot





Componi e personalizza la tua lampada Freeline
/ *Compose and customize your Freeline lamp*

1. Scelta delle luci / *Spot options*

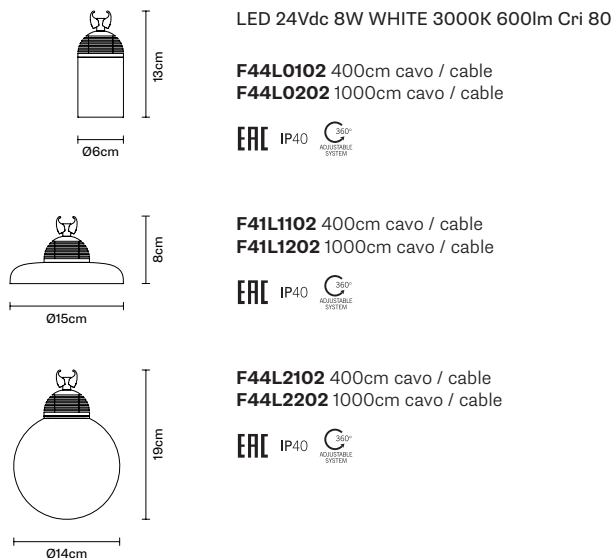

2. Scelta dei rosoni / *Canopies options*

Alimentatore elettronico dimmerabile 60W incluso
/ *60W dimmable electronic driver included*
F44M0102 32,5x6,5x4,6cm

ERC IP40

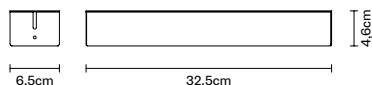

Senza alimentatore
/ *Without driver*
F44M0202 8x6,5x3,6cm

ERC IP40

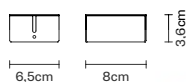

3. Scelta delle barre / *Bar options*

F44M1102 Barra 1m / 1m bar *
F44M1202 Barra 2m / 2m bar *
F44M1302 Barra 3m / 3m bar *

ERC IP40

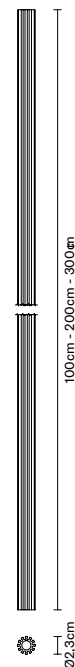

* Sono compresi 2 attacchi a soffitto filettati
e 4 tappi di chiusura per codice
* *Each code includes 2 ceiling fastening kits
and 4 closure caps*

GIUNCO

Marc Sadler



GIUNCO

Marc Sadler

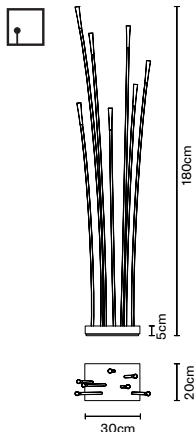

code	electrification	technical info	accessories
------	-----------------	----------------	-------------

F14 C01
01 White

LED 220-240V
7x3.5W
WHITE 3000K
1500lm Cri >80

EAC  IP20
0,19 m³
7,83 kg

INCLUDED:
- LED / LED
- Doppia accensione / Double switch
- Alimentatore elettronico / Electronic driver



Diffusori fissi / Fixed diffusers

F14 C03
01 White

LED 220-240V
7x3.5W
WHITE 3000K
1500lm Cri >80

EAC  IP65
0,19 m³
7,60 kg

INCLUDED:
- LED / LED
- Alimentatore elettronico / Electronic driver



Diffusori fissi / Fixed diffusers

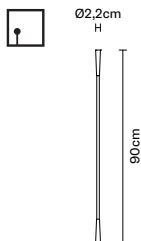

NEW! **F14 C11**
01 White

LED 24Vdc
1x3.5W-120°
WHITE 3000K
220lm Cri 85

EAC  IP65

INCLUDED:
- LED / LED

NOT INCLUDED:
- Alimentatore / Driver



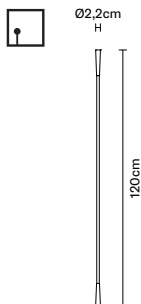

NEW! **F14 C13**
01 White

LED 24Vdc
1x3.5W-120°
WHITE 3000K
220lm Cri 85

EAC  IP65

INCLUDED:
- LED / LED

NOT INCLUDED:
- Alimentatore / Driver





GIUNCO

Marc Sadler

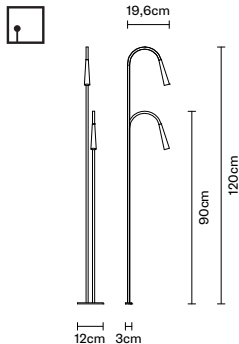

code

electrification

technical info

accessories

NEW! **F14 C51**
01 White

LED 700mA
2x3W-120°
WHITE 3000K
230lm Cri 80



EAC III IP65

INCLUDED:
- LED / LED

NOT INCLUDED:
- Alimentatore / Driver

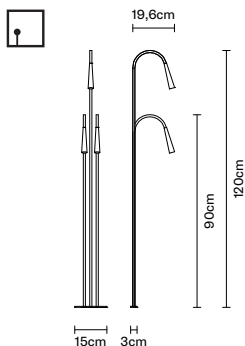

NEW! **F14 C53**
01 White

LED 700mA
3x3W-120°
WHITE 3000K
230lm Cri 80



EAC III IP65

INCLUDED:
- LED / LED

NOT INCLUDED:
- Alimentatore / Driver

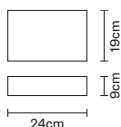

NEW! **F14 Z10**

EAC IP65

NOT INCLUDED:
- Spots / Spots

Box di alimentazione 24Vdc da esterno. Max 1 lampada, non dimmerabile. Per F14C1114 e F14C1314 / Outdoor power supply box for 24Vdc lights. Max 1 lamp, not dimmable. For F14C1114 and F14C1314

NEW! **F14 Z11**

EAC IP65

NOT INCLUDED:
- Spots / Spots

Box di alimentazione 700mA da esterno. Max 1 lampada, non dimmerabile. Per F14C5114 e F14C5314 / Outdoor power supply box for 700mA lights. Max 1 lamp, not dimmable. For F14C5114 and F14C5314

LAMINIS

FE Design



The collection is composed of modular ceiling and wall lamp models for indoor use, with a metal structure. The possible layouts are endless, and may consist of one or two electrically powered “veils”, or just one “veil”, without electrical power. The hanging lamp models are in polished chrome / gilded metal; the modular strips are available in either polished or gilded aluminium. The glass panels, in different sizes and patterns, are supported by means of stainless steel cables, and are also available in different colours on request. The lamps run on mains power and are suitable for halogen and LED bulbs.

La collezione si costituisce di strutture componibili in metallo da soffitto e parete per interno. Le soluzioni compositive sono illimitate e personalizzabili, a due o un velo elettrificato o ad un velo non elettrificato. Le sospensioni sono in metallo cromato lucido e dorato, le barre modulari sono disponibili con rivestimenti in alluminio brillantato e alluminio dorato. Cavi in acciaio inox sorreggono i vetri, di diverse misure e fantasie, che, su richiesta, sono disponibili anche in colorazioni diverse. L'elettrificazione è a tensione di rete per lampade alogene e per LED.



LENS

—
Lucie Koldova



LENS

Lucie Koldova

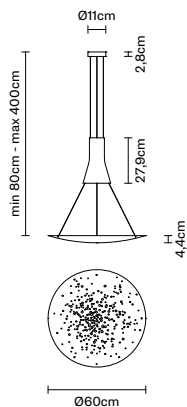

code

electrification

technical info

accessories



F46 A01
14 *Satin-finish*
burnished
56 *Rust*
76 *Bronze*

LED 220-240V
 1x26W-35°
 WHITE 3000K
 2400lm Cri 92



EAC IP40



INCLUDED:
 - LED / LED
 - Alimentatore elettronico dimmerabile /
Dimmable electronic driver

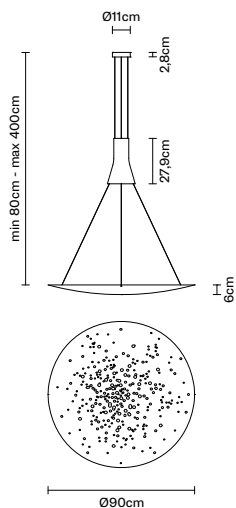

F46 A03
14 *Satin-finish*
burnished
56 *Rust*
76 *Bronze*

LED 220-240V
 1x26W-35°
 WHITE 3000K
 2400lm Cri 92



EAC IP40



INCLUDED:
 - LED / LED
 - Alimentatore elettronico dimmerabile /
Dimmable electronic driver



LENS

Lucie Koldova

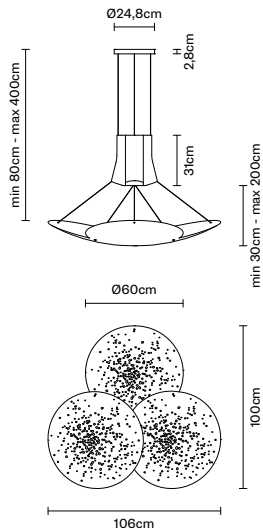

code

electrification

technical info

accessories



F46 A05
14 *Satin-finish*
14 *Satin-finish*
56 *Rust*
76 *Bronze*
99 *Multicolour*

LED 220-240V
 3x26W-35°
 WHITE 3000K
 7200lm Cri 92



EAC IP40



INCLUDED:
 - LED / LED
 - Alimentatore elettronico dimmerabile /
 Dimmable electronic driver

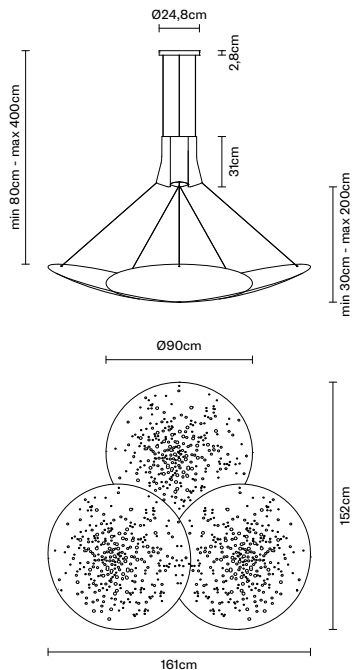

F46 A07
14 *Satin-finish*
14 *Satin-finish*
56 *Rust*
76 *Bronze*
99 *Multicolour*

LED 220-240V
 3x26W-35°
 WHITE 3000K
 7200lm Cri 92



EAC IP40



INCLUDED:
 - LED / LED
 - Alimentatore elettronico dimmerabile /
 Dimmable electronic driver

METROPOLE

Marc Sadler

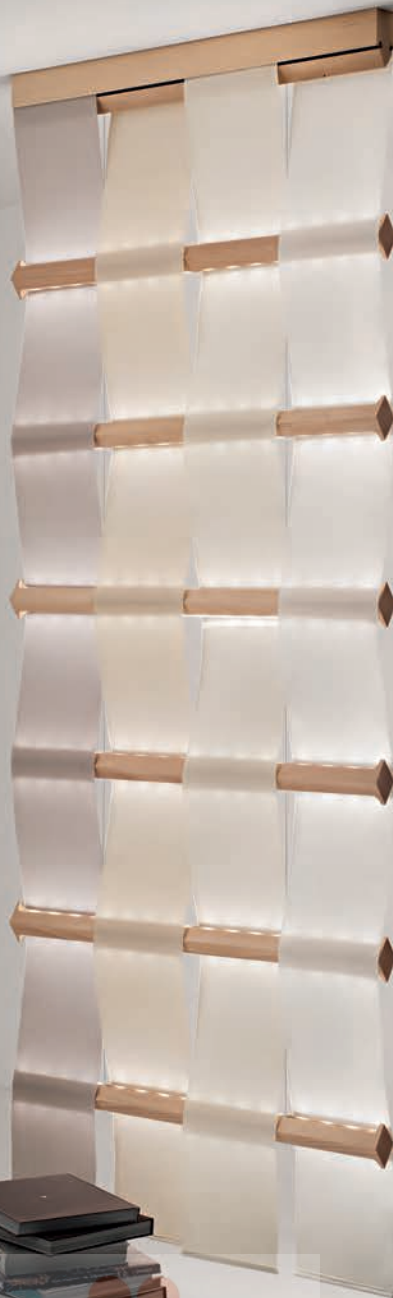

LUSTROGRAD
ОПТОВЫЕ ПРОДАЖИ СВЕТИЛЬНИКОВ

METROPOLE

Marc Sadler

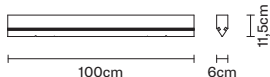

NEW! **F42 M01**
69 Light wood
colour

EAC IP20

INCLUDED:
- Alimentatore elettronico dimmerabile /
Dimmable electronic driver

Listello starter con alimentatore elettronico dimmerabile 60W. Max 14 strip LED /
Starter listel with 60W dimmable electronic driver. Max 14 strip LED

NEW! **F42 M02**
69 Light wood
colour

EAC

Listello starter senza alimentatore / Starter listel without driver

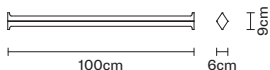

NEW! **F42 M11**
69 Light wood
colour

EAC

Listello senza sorgente luminosa / Listel without light source

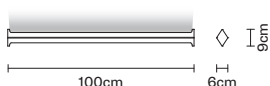

NEW! **F42 M12**
69 Light wood
colour

LED 220-240V
1x4W-120°
WHITE 3000K
500lm Cri >80

EAC IP20

INCLUDED:
- 1 Strip LED / 1 Strip LED



LED

Listello con strip LED superiore / Listel with upper strip LED



NEW! **F42 M13**
69 Light wood
colour

LED 220-240V
1x4W-120°
WHITE 3000K
500lm Cri >80

EAC IP20

INCLUDED:
- 1 Strip LED / 1 Strip LED



LED

Listello con strip LED inferiore / Listel with lower strip LED

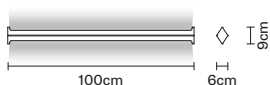

NEW! **F42 M14**
69 Light wood
colour

LED 220-240V
2x4W-120°
WHITE 3000K
1000lm Cri >80

EAC IP20

INCLUDED:
- 2 Strip LED / 2 Strip LED



LED

Listello con strip LED superiore e inferiore / Listel with upper and lower strip LED



NEW! **F42 V01**
01 White
09 Ivory
16 Beige
75 Light grey

EAC

Tela fonoassorbente, ignifuga, autoestinguente larga 25cm. Prezzo al metro. Al momento dell'ordine comunicare all'azienda le misure del progetto / Soundproof, fire-resistant, self-extinguishing canvas 25cm wide. Price for by meter. When ordering, communicate to the company the dimensions of the project

OLYMPIC

—
Lorenzo Truant

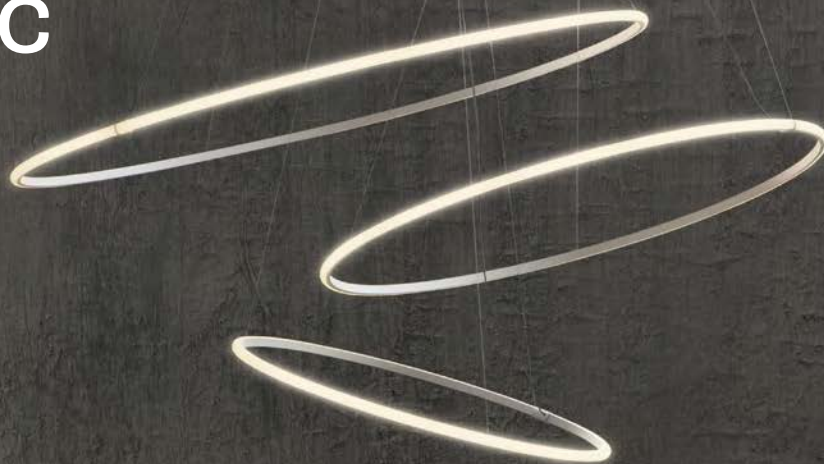

OLYMPIC

Lorenzo Truanti

code

electrification

technical info

accessories

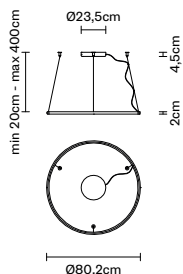

NEW! **F45 A01**
01 White

LED 220-240V
1x56W-120°
WHITE 3000K
6000lm Cri 80

EAC IP40

INCLUDED:

- LED / LED
- Alimentatore elettronico dimmerabile / Dimmable electronic driver

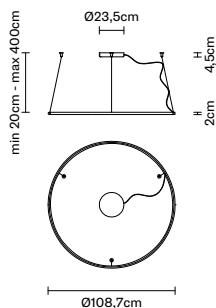

NEW! **F45 A03**
01 White

LED 220-240V
1x76W-120°
WHITE 3000K
8250lm Cri 80

EAC IP40

INCLUDED:

- LED / LED
- Alimentatore elettronico dimmerabile / Dimmable electronic driver

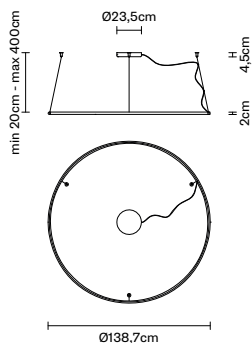

NEW! **F45 A05**
01 White

LED 220-240V
1x98W-120°
WHITE 3000K
10600lm Cri 80

EAC IP40

INCLUDED:

- LED / LED
- Alimentatore elettronico dimmerabile / Dimmable electronic driver





OLYMPIC

Lorenzo Truant

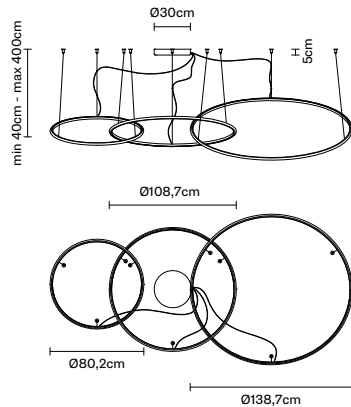

code

electrification

technical info

accessories

NEW! **F45 A11**
01 White

LED 220-240V
1x56W-120°
1x76W-120°
1x98W-120°
WHITE 3000K **LED**
24850lm CRI 80

EAC IP40

INCLUDED:

- LED / LED
- Alimentatore elettronico dimmerabile /
Dimmable electronic driver

Composizione con le tre sospensioni / *Combination of three pendants*



TRIPLA

Desall / Devis Busato & Giulia Ciccarese



TRIPLA

Desall / Devis Busato & Giulia Ciccarese

code

electrification

technical info

accessories

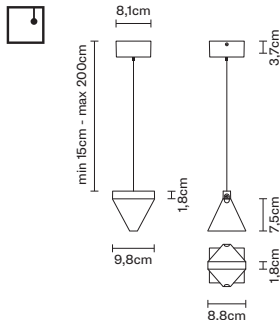

F41 A01

11 Polished
aluminium
21 Anthracite
76 Bronze

LED 220-240V
1x4.3W-120°
WHITE 3000K
540lm Cri >80

[EAC](#)



EAC IP40

INCLUDED:

- LED / LED
- Alimentatore elettronico dimmerabile / Dimmable electronic driver

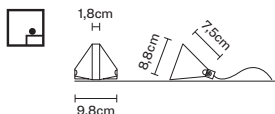

F41 B01

11 Polished
aluminium
21 Anthracite
76 Bronze

LED 220-240V
1x4.3W-120°
WHITE 3000K
540lm Cri >80

[EAC](#)



EAC IP40

INCLUDED:

- LED / LED
- Alimentatore elettronico dimmerabile / Dimmable electronic driver

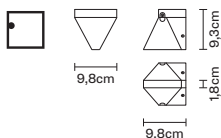

F41 D01

11 Polished
aluminium
21 Anthracite
76 Bronze

LED 220-240V
1x4.3W-120°
WHITE 3000K
540lm Cri >80

[EAC](#)



EAC IP40

INCLUDED:

- LED / LED
- Alimentatore elettronico dimmerabile / Dimmable electronic driver

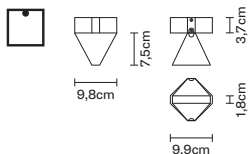

F41 E01

11 Polished
aluminium
21 Anthracite
76 Bronze

LED 220-240V
1x4.3W-120°
WHITE 3000K
540lm Cri >80

[EAC](#)



EAC IP40

INCLUDED:

- LED / LED
- Alimentatore elettronico dimmerabile / Dimmable electronic driver

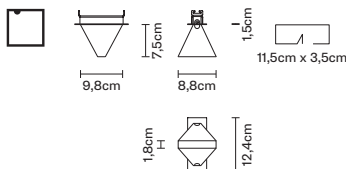

F41 F01

11 Polished
aluminium
21 Anthracite
76 Bronze

LED 220-240V
1x4.3W-120°
WHITE 3000K
540lm Cri >80

[EAC](#)



EAC IP40

INCLUDED:

- LED / LED
- Alimentatore elettronico dimmerabile / Dimmable electronic driver



TRIPLA

Desall / Devis Busato & Giulia Ciccarese

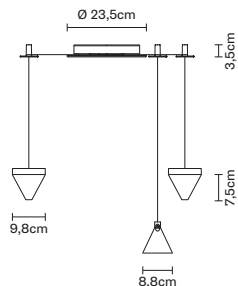

code

electrification

technical info

accessories

F41 G01

11 Polished aluminium
21 Anthracite
76 Bronze

LED 220V-240V
3x4.3W-120°
WHITE 3000K
1620lm CRI >80



LED

EAC IP40

INCLUDED:

- LED / LED
- Alimentatore elettronico dimmerabile / Dimmable electronic driver

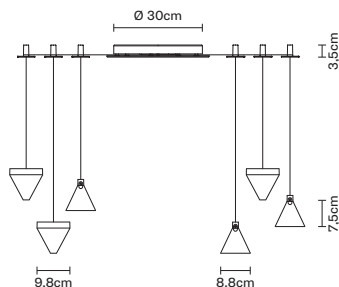

F41 G03

11 Polished aluminium
21 Anthracite
76 Bronze

LED 220V-240V
6x4.3W-120°
WHITE 3000K
4860lm CRI >80



LED

EAC IP40

INCLUDED:

- LED / LED
- Alimentatore elettronico dimmerabile / Dimmable electronic driver

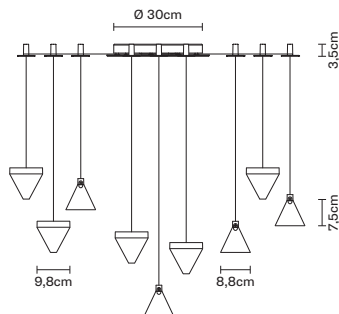

F41 G05

11 Polished aluminium
21 Anthracite
76 Bronze

LED 220V-240V
9x4.3W-120°
WHITE 3000K
3240lm CRI >80



LED

EAC IP40

INCLUDED:

- LED / LED
- Alimentatore elettronico dimmerabile / Dimmable electronic driver

Componi e personalizza la tua lampada Tripla
/ *Compose and customize your Tripla lamp*

1. Scelta delle luci / *Spot options*



LED 350mA 4,3W WHITE 3000K 540lm Cri>80

Dimmerabile / *Dimmable*

Struttura in alluminio lucido
/ *Polished aluminium structure*
F41L0111 300cm cavo / cable
F41L0211 600cm cavo / cable
F41L0311 900cm cavo / cable

Struttura verniciata grigia antracite
/ *Anthracite painted structure*
F41L0121 300cm cavo / cable
F41L0221 600cm cavo / cable
F41L0321 900cm cavo / cable

Struttura verniciata bronzo
/ *Bronze painted structure*
F41L0176 300cm cavo / cable
F41L0276 600cm cavo / cable
F41L0376 900cm cavo / cable

ERAC IP55

* Sono compresi 3 rocchetti di decentramento per codice
* *Each code provides 3 spoils for wire support*

2. Scelta dei rosoni / *Canopies options*

Rosoni circolari / *Round canopies*

Alimentatore dimmerabile incluso / *Dimmable driver included*

Struttura in alluminio lucido / *Polished aluminium structure*

F41M0111 Ø 23,5cm - 350mA (1-3 spots) - Dim. push button 1..10V

F41M0311 Ø 30cm - 350mA (4-9 spots) - Dim. push button 1..10V, DALI

Struttura verniciata grigia antracite / *Anthracite painted structure*

F41M0121 Ø 23,5cm - 350mA (1-3 spots) - Dim. push button 1..10V

F41M0321 Ø 30cm - 350mA (4-9 spots) - Dim. push button 1..10V, DALI

Struttura verniciata bronzo / *Bronze painted structure*

F41M0176 Ø 23,5cm - 350mA (1-3 spots) - Dim. push button 1..10V

F41M0376 Ø 30cm - 350mA (4-9 spots) - Dim. push button 1..10V, DALI

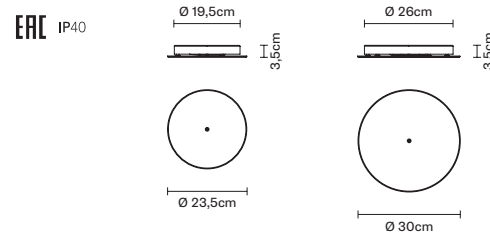

Rosone a incasso / *Recessed canopy*

Alimentatore remoto escluso / *Remote power supply not included*

F41Z1001 Ø 3cm - (1 spot)

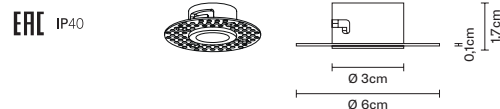

Box per esterno / *Outdoor box*

Alimentatore incluso / *Driver included*

F41Z11 24x19x9cm - (max 10 spot)

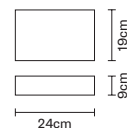

3. Accessori disponibili / Available accessories

F41Z01C100

Rocchetto di decentramento / *Spool for wire support*

F41Z0302

Spezzafile con interruttore / *Power plug with switch*

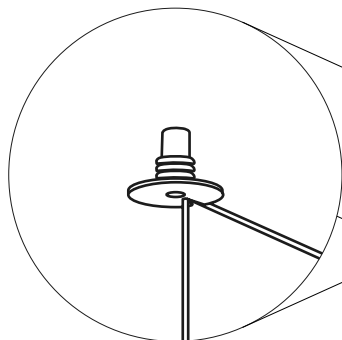

Possibilità di avvolgere fino a 1m di cavo.
Possibility to wind the cable up to 1m.

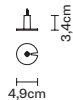

4. Il sistema / The system

Personalizza la posizione degli spot.
Customize spots position.

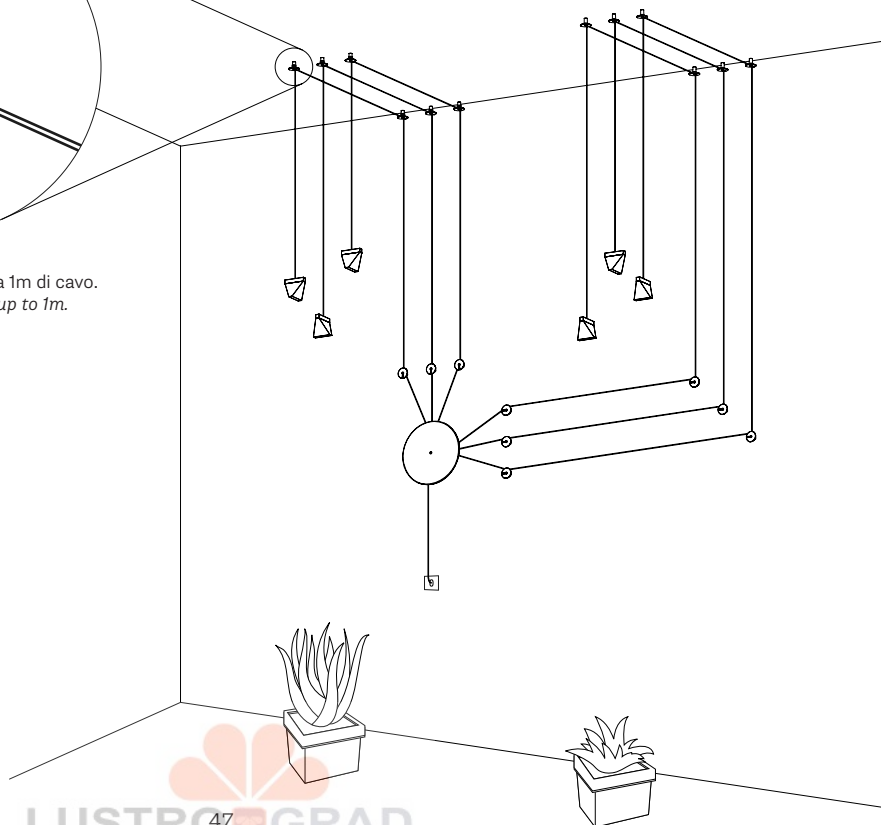



IP CAT/MKT/03175000

<https://www.lustrograd.com/vendors/fabbian/>



Italy

Fabbian Srl soc. unipersonale
via Santa Brigida, 50
31020, Castelminio di Resana
Treviso
tel +39 0423 4848
fax +39 0423 484395
numero verde 800 800 444
www.fabbian.com

sales

italia@fabbian.com
export@fabbian.com

mkt & com

marketing@fabbian.com

Usa and Canada

Fabbian Usa Corp.
307 W 38th St Ste 1103
New York, NY 10018, Usa
Ph. +1 646 518 4160
Fax +1 646 518 4180
www.fabbian.us

sales

usa@fabbian.com
canada@fabbian.com

mkt & com

marketing.usa@fabbian.com