



























**LEDS C4**  
The interiors collection  
2019 - 20

Pendant / Suspensión				
				
	Veneto P.10	Attic P.16	Khoi P.22	
				
Contrast P.26	Cherry P.28	Sugar P.29	Caprice P.30	Stylus P.30
				
Funk P.30	Raw P.30	Eclipse P.31	Pipe P.31	Vintage P.31
				
Vintage P.31	Vintage P.32	Vintage P.32	Vintage P.33	Vintage P.33
Wall / Pared				
				
	Gamma P.36	Readme P.40	Elamp P.44	

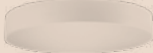
				
Organic P.46	Fino P.48	Radar P.52	Lire P.54	Drone P.55
				
Tip P.56	Link P.57	Contrast P.58	Attic P.60	Stylus P.62
				
Ivy P.62	Book P.62	Bed P.62	Gloss P.63	Bali P.63
				
Michigan P.63	Bristol P.63	Funk P.64	Pipe P.64	Kub P.64
				
Eclipse P.64	Ges P.65	Vintage P.65	Duna P.65	Room P.65

<b>Table &amp; Floor / Sobremesa y Pie</b>				
				
	Gamma P.68	Elamp P.72	Organic P.76	
				
Organic P.76	Funk P.80	Elva P.80	Michigan P.80	Bristol P.80
				
Funk P.81	Vintage P.81	Michigan P.81	Bristol P.81	

<b>Bath / Baño</b>				
				
	Play Optics P.84	Toilet slim P.86	Vetro P.87	
<b>Architectural Lighting / Iluminación Arquitectónica</b>				
				
	Atom P.90	Low voltage P.94	Play Deco Optics P.98	
				
Play Optics P.102	Mini Play P.106	Luno P.108	Taglio di luce P.112	Maai P.116
				
Asai P.120				
			<b>Technical Information / Información Técnica</b>	<b>Connected lighting / Iluminación conectada</b>
			P.126	P.215

( ENG ) For mankind, lighting has always been an indisputably essential part of life. It provides wellbeing and comfort, makes the inhabitable habitable, adds functionality to spaces and reveals the beauty of each landscape and architectural attribute. And LEDS C4 contributes to improving the light quality of our surroundings by optimising the design and engineering of its products.

( ESP ) Para el ser humano, la luz ha sido siempre un elemento indiscutiblemente esencial. Aporta bienestar y confort, convierte lo inhóspito en habitable, dota de funcionalidad a los espacios y revela lo mejor de cada paisaje y de cada atributo arquitectónico. Y LEDS C4 contribuye a mejorar la calidad lumínica de nuestro entorno optimizando el diseño y la ingeniería de sus productos.

Pendant / Suspensión

Pendant

Suspensión

# Veneto



(ENG) The Veneto collection of pendant lamps reinterprets classic luxury with a luminaire with simple forms and fine finishes that provides intimate and refined lighting. The embossing gives it character and the gold detail balances the presentation.

(ESP) La colección de colgantes Veneto reinterpretamos el lujo clásico con una luminaria de formas simples y acabados impecables que aporta una iluminación íntima y refinada. El grabado le aporta carácter y el detalle en dorado equilibra la puesta en escena.

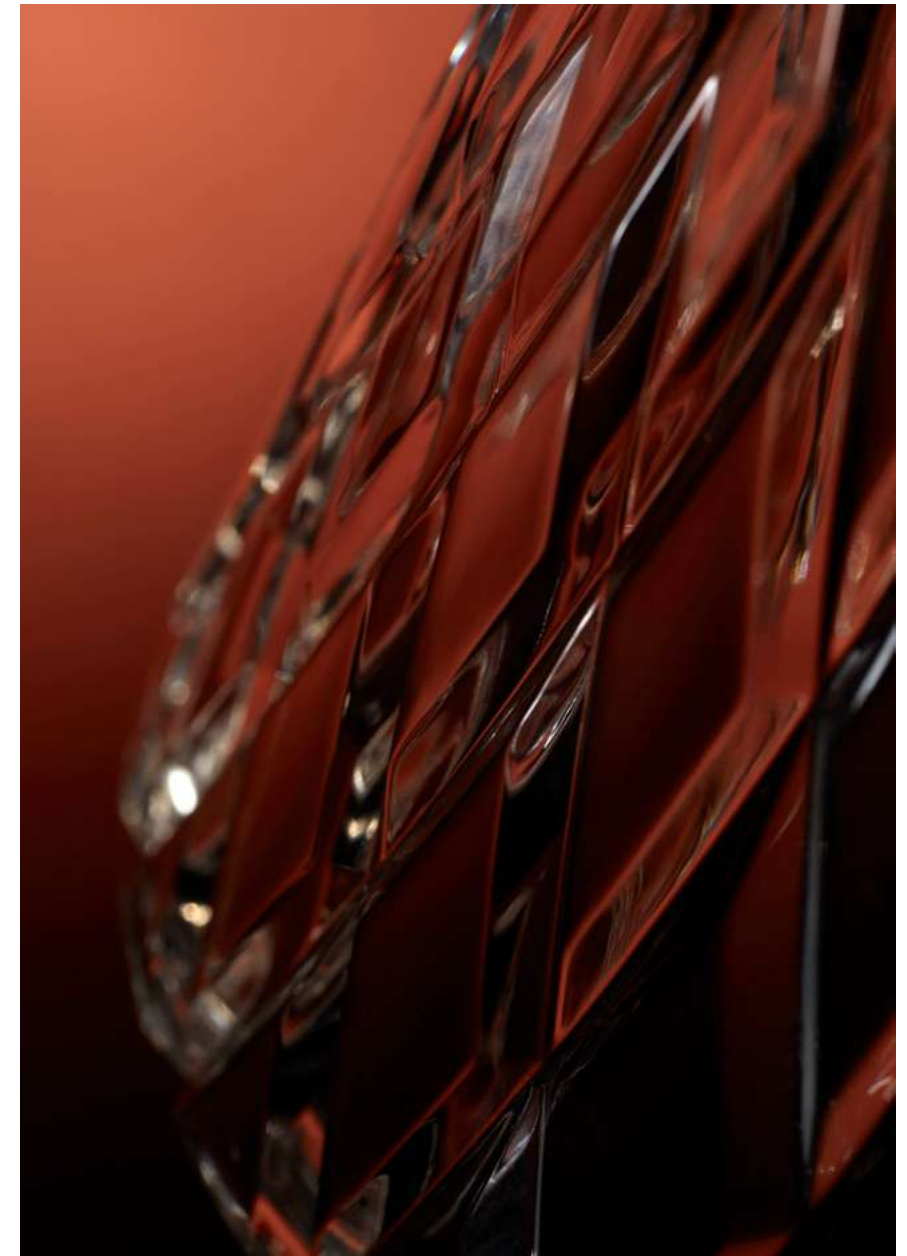

- ENG. The embossing adds complexity to the piece and creates an interesting lighting effect.
- ESP. El grabado añade complejidad a la pieza y crea un interesante efecto de luz.







— ENG. In its multiple version, this piece from Benedito Design makes it possible to create delicate compositions.  
— ESP. En su versión múltiple, esta pieza de Benedito Design permite crear delicadas composiciones.



1 x LED 6,7W 2700K or 3/4/5/6 x LED 15/20/25/30W 2700K  
TEC. INFO P.126

Pendant

Suspensión

(ENG) A modular series with a contemporary design created by combining a suspension system with conical or cylindrical-shaped shades. The attractive cables and structures offer an infinite number of aesthetic and configuration possibilities.

# Attic



(ESP) Una serie modular de diseño contemporáneo que se construye combinando un sistema de suspensión con pantallas de formas cónicas o cilíndricas. El sugerente juego de cables y cuerpos ofrece infinitas posibilidades compositivas y plásticas.



- ENG. The flexibility of this luminaire makes it suitable for any space.
- ESP. Su flexibilidad la convierte en una luminaria capaz de llenar cualquier espacio.

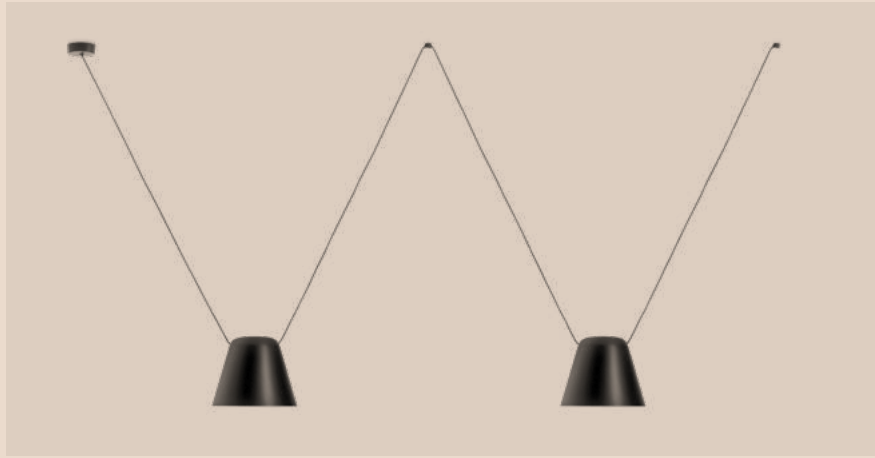

— ENG. The combination of cables and light sources creates unexpected shapes on the ceiling of the space.  
— ESP. La combinación de cables y puntos de luz crea inesperados dibujos en el techo de la estancia.

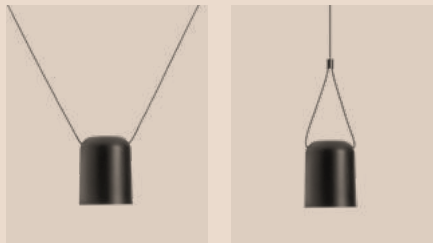
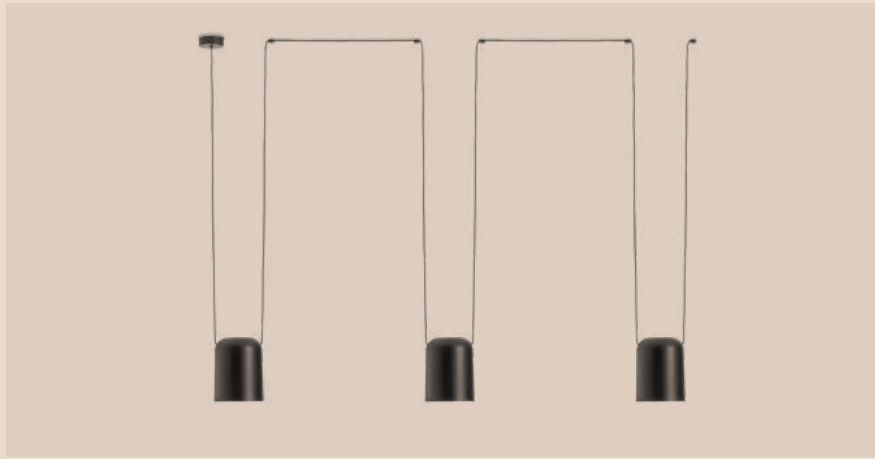
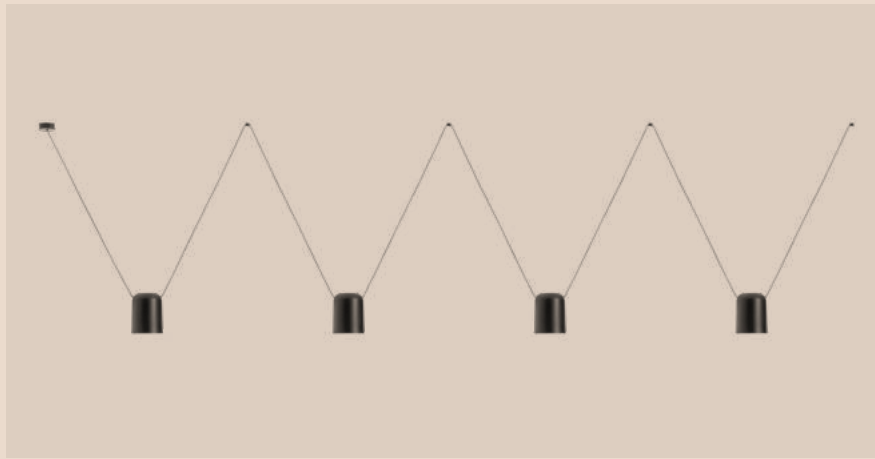

1/2/3/4 x E27  
TEC. INFO P.127

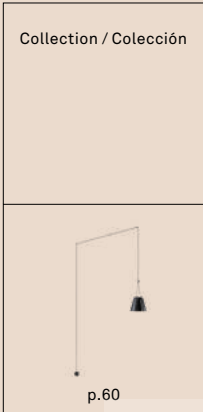

Pendant

Suspensión

# Khói



(ENG) Oriental delicacy in its purest state; from the concept to the shape of its structure. When switched on, the glass captures the light in its interior, creating a unique optical effect capable of lending warmth to any space and enhancing its lightness.



— ENG. Khoi is a design object: the paradigm of the perfect combination of functionality and aesthetics.  
— ESP. Khoi es un objeto de diseño: el paradigma de la unión perfecta de funcionalidad y estética.

(ESP) Delicadeza oriental en estado puro; desde las formas de su estructura al concepto. Al encenderse, el cristal atrapa la luz en su interior creando un efecto óptico único capaz de aportar calidez a cualquier espacio y enfatizar su ligereza.

# Contrast

(ENG) A versatile design with an industrial look and warm light, specially designed for restaurants. The natural wood or concrete base of the pendant lamp can be combined with two shade sizes, with a choice of black, gold or a colour from The Colors range.



(ESP) Un versátil diseño de aire industrial y luz cálida, especialmente concebido para restaurantes. La madera natural o cemento del soporte del colgante puede combinarse con dos tamaños de pantalla, en negro, dorado o en la gama The Colors.

NAHTRANG STUDIO

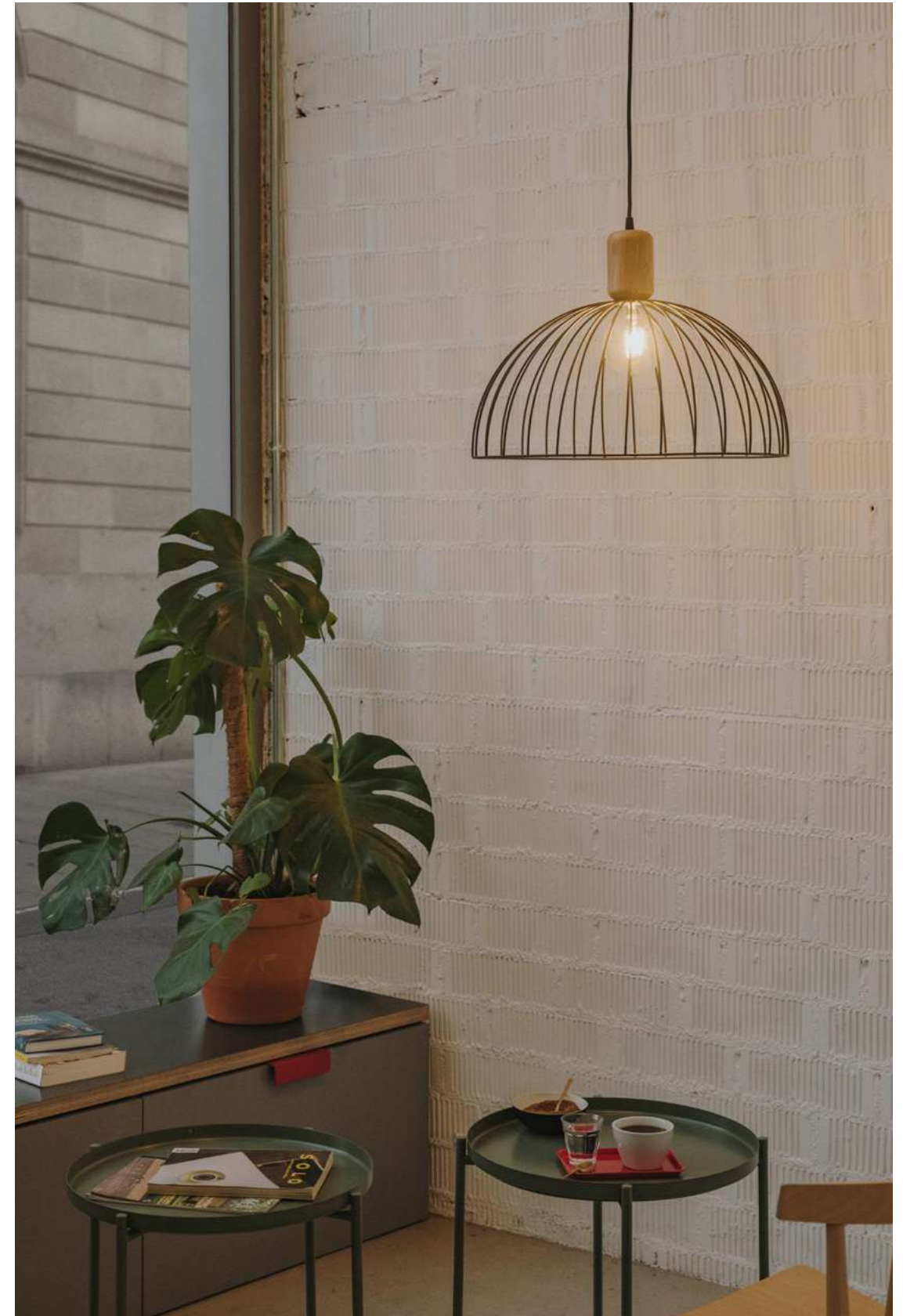
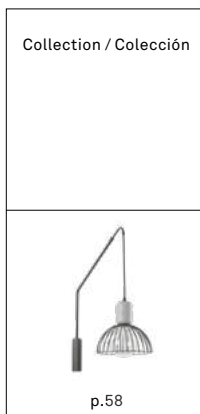

1 x E27  
 TEC. INFO P.129



— ENG. A hanging lamp with versatile formats and finishes, with dimming and colour temperature options.  
— ESP. Colgante de formatos y acabados versátiles con opciones de dimming y temperatura de color.

— ENG. An industrially-inspired bell-shaped LED with high lumen power and warm light.  
— ESP. Campana LED de inspiración industrial con alta potencia luminica y luz cálida.



# Cherry

1 x LED 8,6W 2700/3000K  
TEC. INFO P.130

# Sugar

1 x LED 26,6W 2700K  
TEC. INFO P.131



**Caprice**



1 x LED 24/32/28W 3000K  
TEC. INFO P.131

**Stylus**



1 x LED 7,5W 3000K  
TEC. INFO P.132

**Eclipse**



1 x LED 7W 2700K or 1 x E27  
TEC. INFO P.134

**Pipe**



1 x GU10  
TEC. INFO P.135

**Raw**



1 x LED 14W 3000K or 3 x LED 38,5W 3000K  
TEC. INFO P.133

**Funk**



3/5 x E27  
TEC. INFO P.134

**Vintage**



1 x LED 8,3W 3000K  
TEC. INFO P.136

**Vintage**



1 x E27  
TEC. INFO P.137

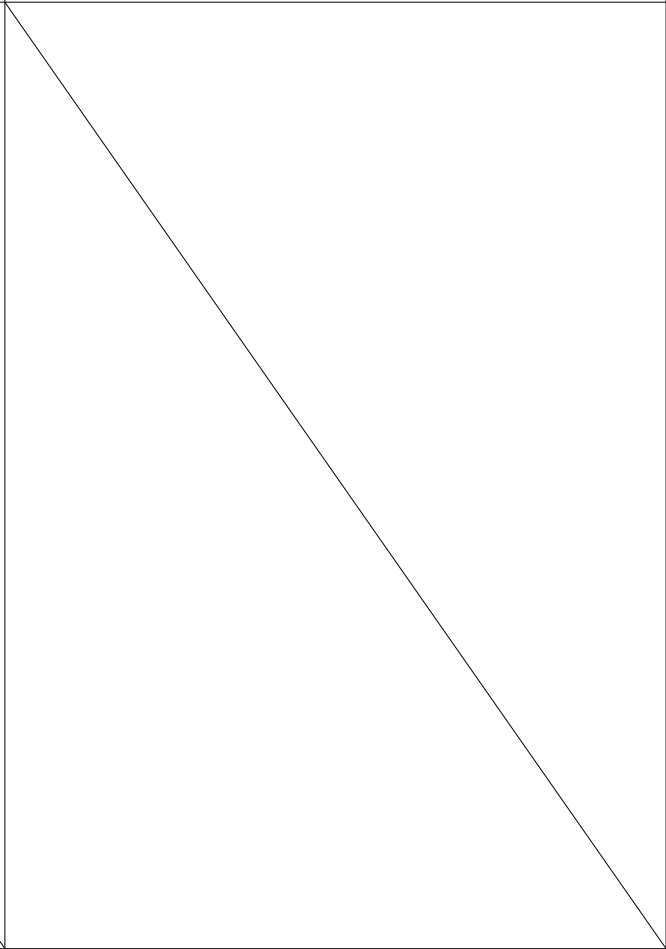
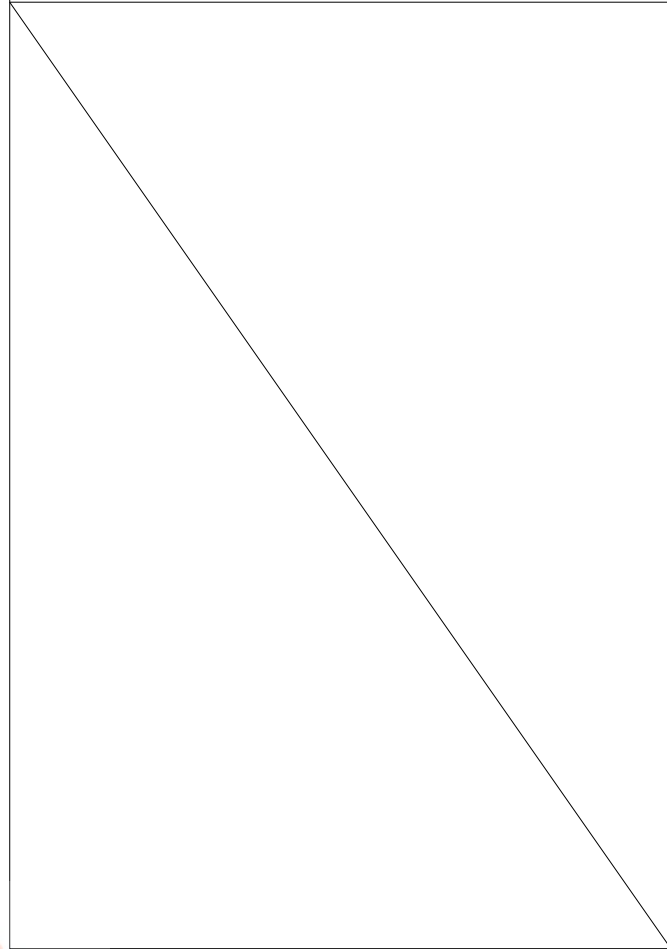
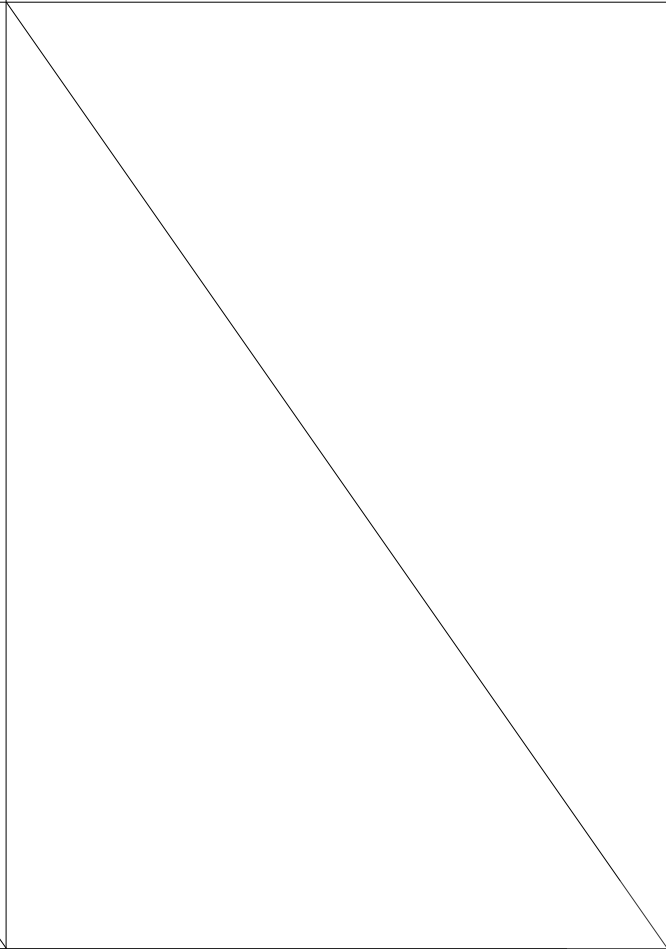
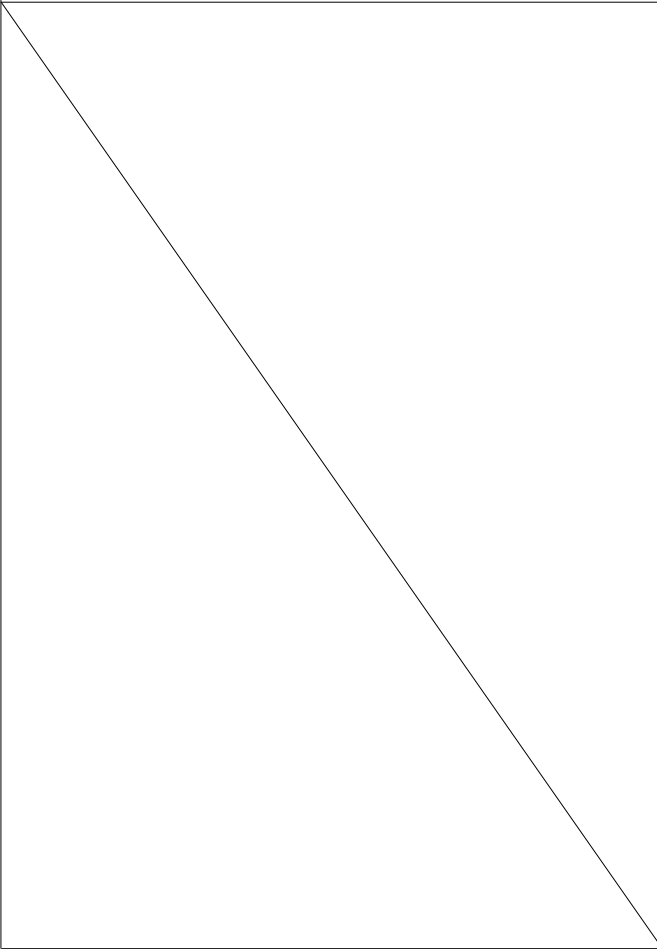
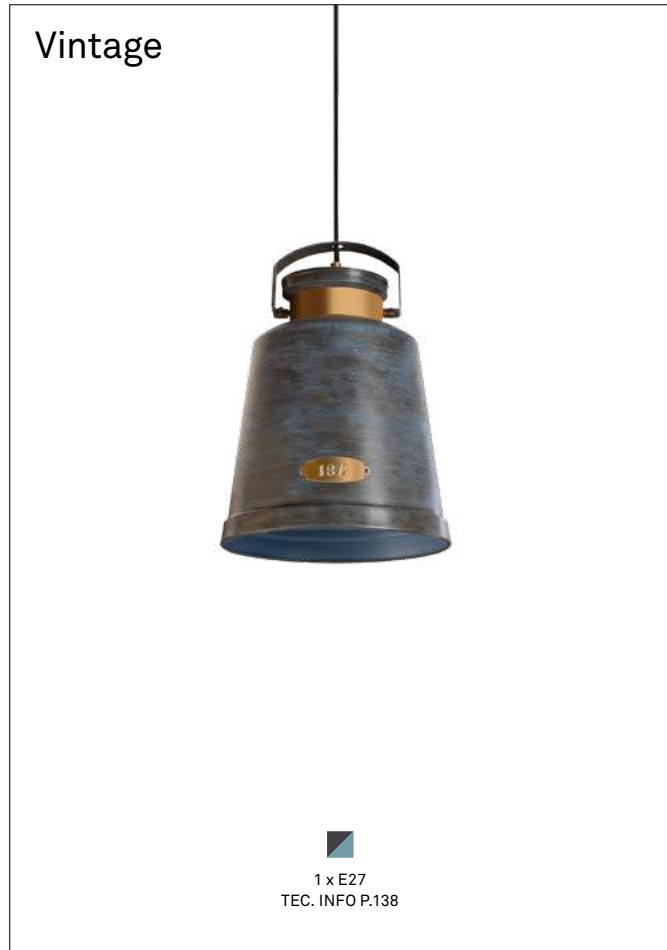

Wall / Pared

Wall

Pared

( ENG ) With a minimalist design, it stands out for its excellent finishes and a flexibility that makes it perfect for the hotel sector. Square or round base, with or without a USB port, with or without a shade, recessed or table version. It is supplied in 4 different finishes and features over 60 options.



# Gamma



- ENG. Its functional but contemporary design integrates perfectly with any architecture or atmosphere.
- ESP. Su diseño funcional pero contemporáneo se integra de forma impecable en cualquier arquitectura y ambiente.

(ESP) Con un diseño minimalista, destaca por sus excelentes acabados y una flexibilidad que la hacen perfecta para el sector hotelero. De base cuadrada o redonda, con o sin USB, con o sin pantalla y empotrada o en versión de sobremesa, cuenta con más de 4 acabados y más de 60 posibilidades.

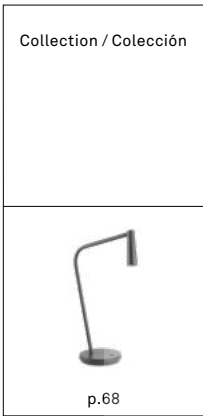
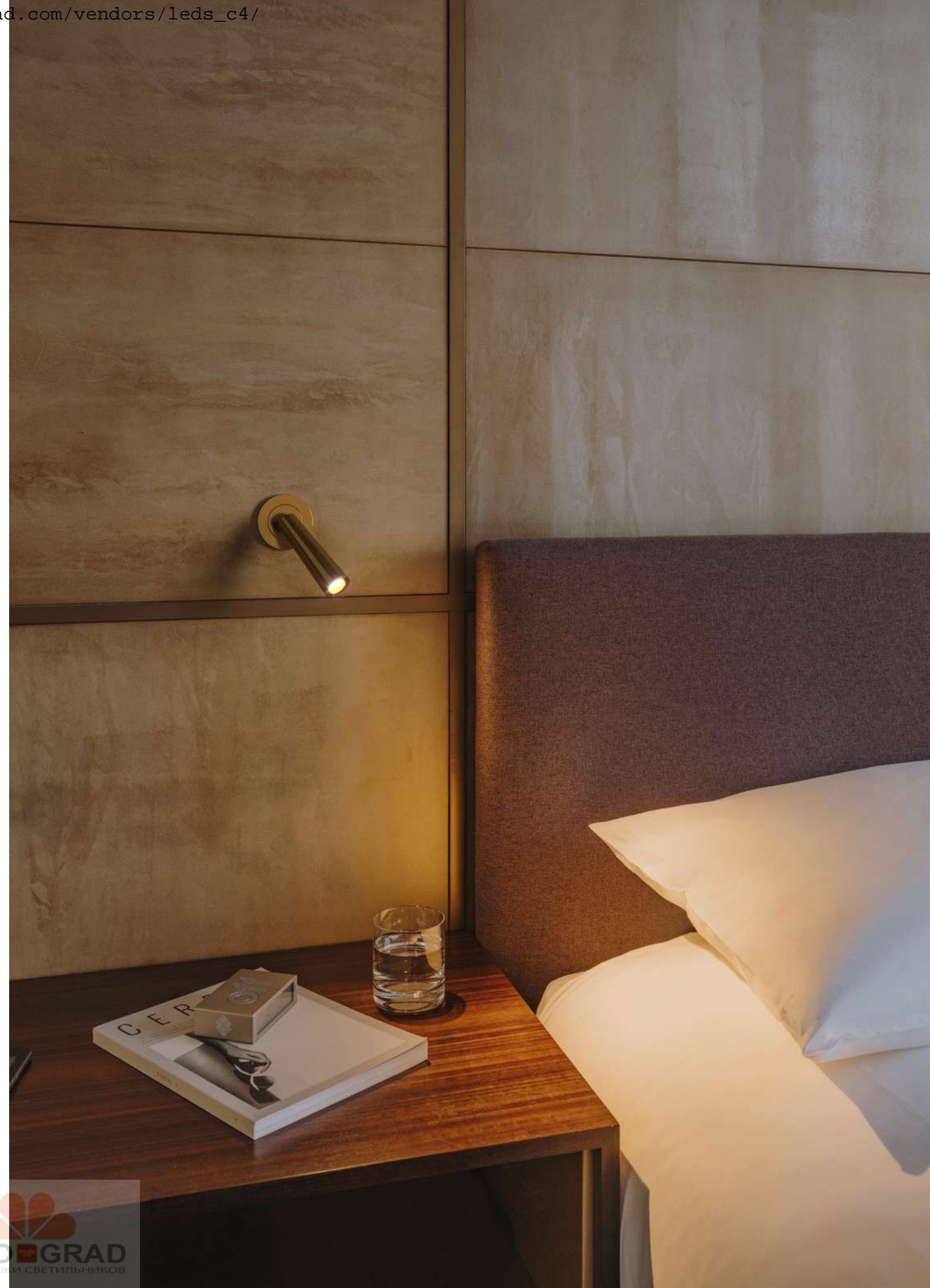

1 x LED 2,2W 2700K  
TEC. INFO P.139

Wall

Pared

# Readme

(ENG) The classic headboard lamp reinterpreted by the contemporary and casual gaze of Francesc Vilaró. With a single point of light, you can choose between ambient lighting or a reading lamp by directing the beam towards the shade or towards the bed.





(ESP) El clásico cabezal de cama reinterpretado por la mirada contemporánea y desenfadada de Francesc Vilaró. Con un único punto de luz, podemos elegir entre una iluminación de ambiente o de lectura, direccionando el halo hacia la pantalla o hacia la cama.



— ENG. With noble metal finishes, the effect of the diffused light from the shade creates an intimate and relaxed atmosphere.

— ESP. De acabados metálicos y nobles, el efecto de luz degradada de la pantalla crea un ambiente íntimo y relajado.

Wall

Pared

# Elamp

(ENG) This multifunctional luminaire with a contemporary design is the fruit of the combination of multiple planes with basic geometrical forms. Designed with the mobile phone in mind, all models include a USB port and the table model includes wireless charging technology.



(ESP) De la unión de múltiples planos con formas geométricas básicas nace esta luminaria multifuncional de diseño contemporáneo. Centrada en el teléfono móvil, incluye USB en todas sus versiones y tecnología de carga inalámbrica en la de sobremesa.



1 x LED 9W 2700K + 1 x LED 2,2W 2700K

TEC. INFO P.141

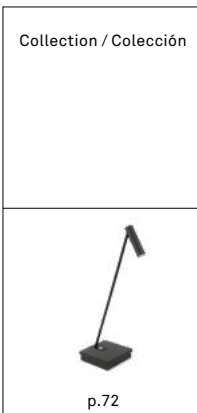

FRANCESC VILARÓ





Wall

Pared

( ENG ) Flowers, leaves and other organic elements have inspired the subtle forms of this luminaire with a distinct personality that embodies the icons of the 1950s. It integrates effortlessly into any setting, reflecting the volatile elegance of the natural world.

( ESP ) Flores, hojas y otros elementos orgánicos inspiran las formas suaves de una luminaria con marcada personalidad que revive iconos de los años 50 y se integra en el entorno destilando la elegancia volátil del mundo natural.

# Organic

Collection / Colección
 <p>p.76</p>
 <p>p.76</p>



1 x E14  
TEC. INFO P.141

ÀLEX & MANEL LLUSCÀ



Wall

Pared

# Fino

(ENG) The minimalist design of this light guarantees excellent architectural integration, reducing its visual impact to the maximum. It allows you to bathe spaces with warm light to create the perfect balance between functionality and decoration.



(ESP) El diseño minimalista de este perfil de luz garantiza una exquisita integración arquitectónica reduciendo al máximo su impacto visual. Permite llenar los espacios de luz cálida creando el equilibrio perfecto entre funcionalidad y decoración.

1 x LED 10,8/21,6W 2700K  
TEC. INFO P.142



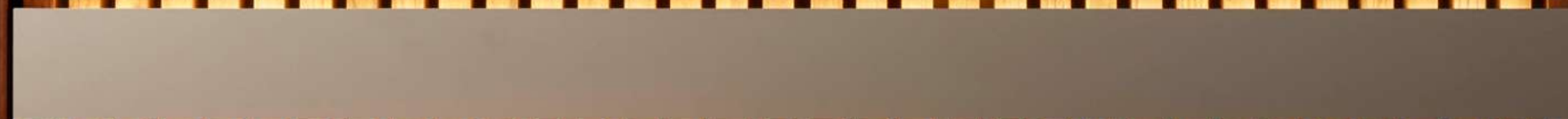



(ESP) La máxima expresión del minimalismo, con un diseño moderno en el que solo tiene cabida lo esencial.

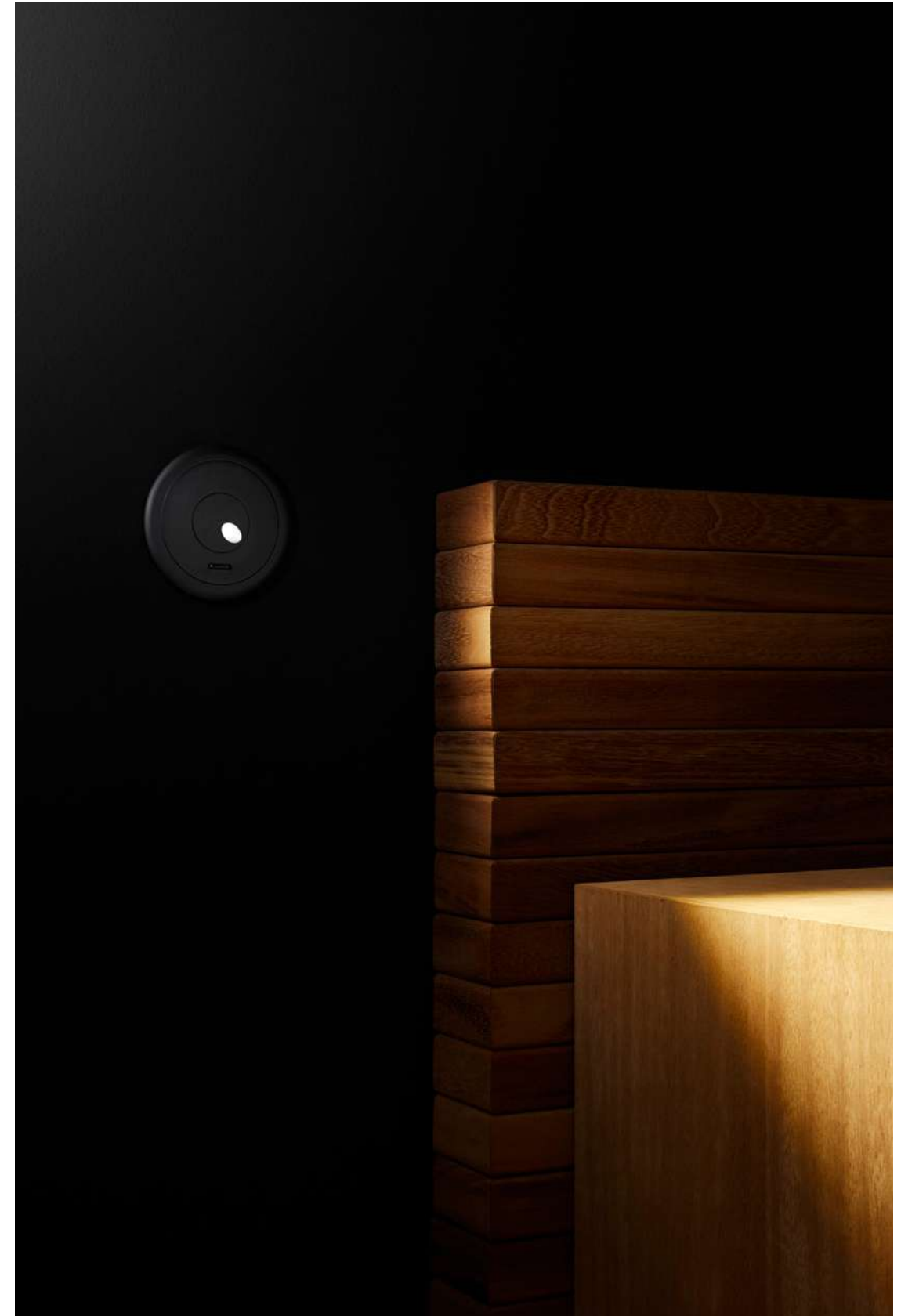

# Radard

(ENG) This is minimalism taken to its maximum expression, with a modern design that includes only the essential.



# Lire

  
 1 x LED 2,2W 3000K  
 TEC. INFO P.143

— ENG. A reading lamp sconce with a directed spotlight and a design that fits perfectly into any room.

— ESP. Aplique de lectura con un foco de luz dirigida y un diseño que se integra en cualquier espacio.

— ENG. A multi-purpose deco-tech spotlight with a wide range of trendy finishes.

— ESP. Reflector deco-tech multifuncional con una variada gama de acabados de tendencia.



# Drone

  
 1/2 x 7/14W 2700K  
 TEC. INFO P.143

— ENG. Flexible in its installation, with a touch dimmer switch on the head of the lamp, making it more functional.

— ESP. Flexible en su instalación y con touch dimming en el cabezal para mayor funcionalidad.



— ENG. The adjustable lamp of the 21<sup>st</sup> century, with high-quality finishes and downlighting, for greater comfort.

— ESP. El flexo del siglo XXI con luz cenital para mayor confort visual y acabados de alta calidad.



# Tip

  
1 x LED 2,2W 3000K  
TEC. INFO P.144

# Link

  
1 x LED 2,1W 2700K  
TEC. INFO P.144



— ENG. The extendable sconce allows the user to direct the light, to create different areas. Ideal for use in restaurants.

— ESP. El aplique telescópico permite orientar el haz de luz para crear ambientes y es ideal para restauración.

# Contrast



— ENG. A wall light with clean and delicate lines that adds a touch of personality to any space.  
— ESP. Aplique de suspensión de líneas puras y delicadas que da personalidad a cualquier espacio.

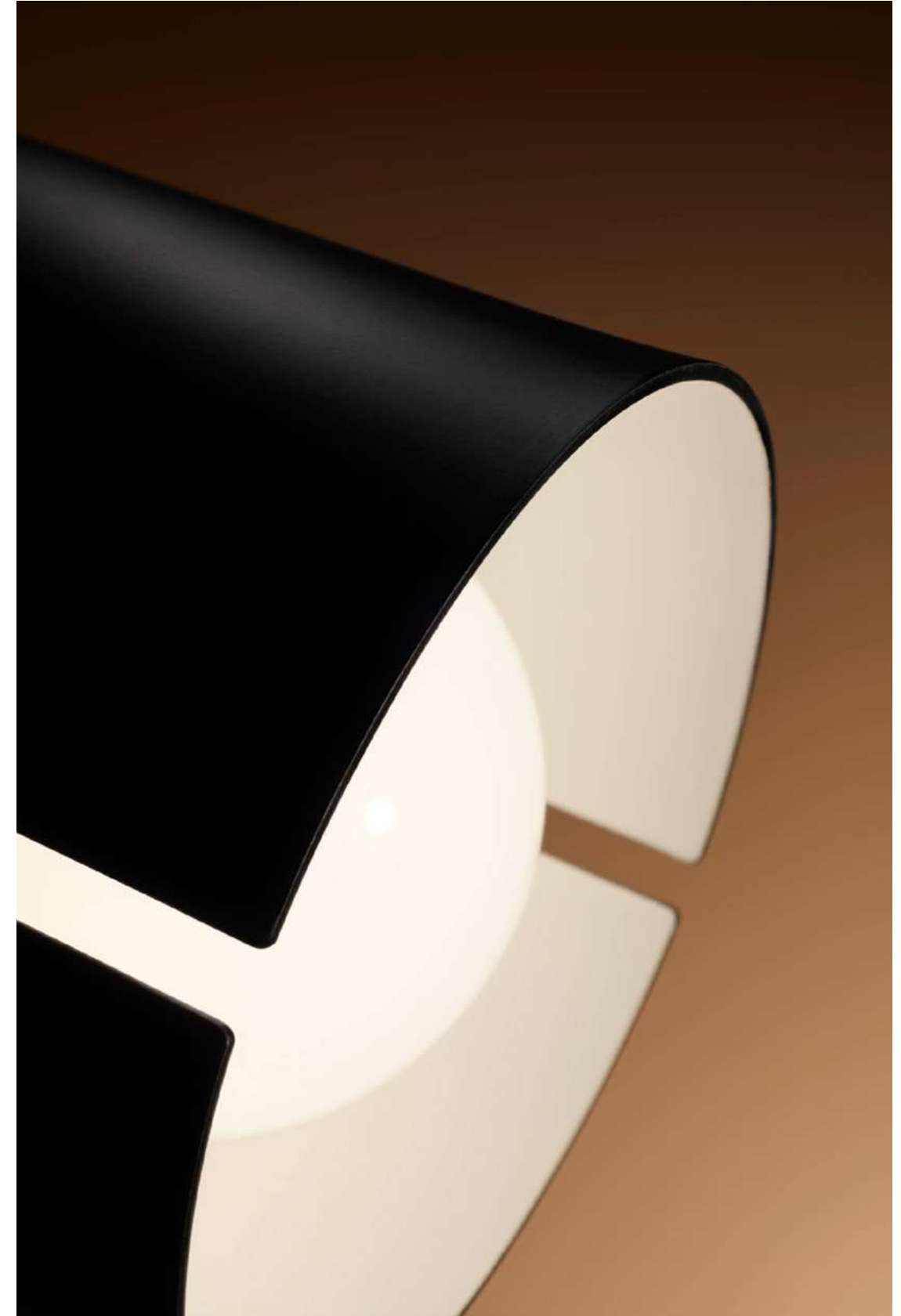
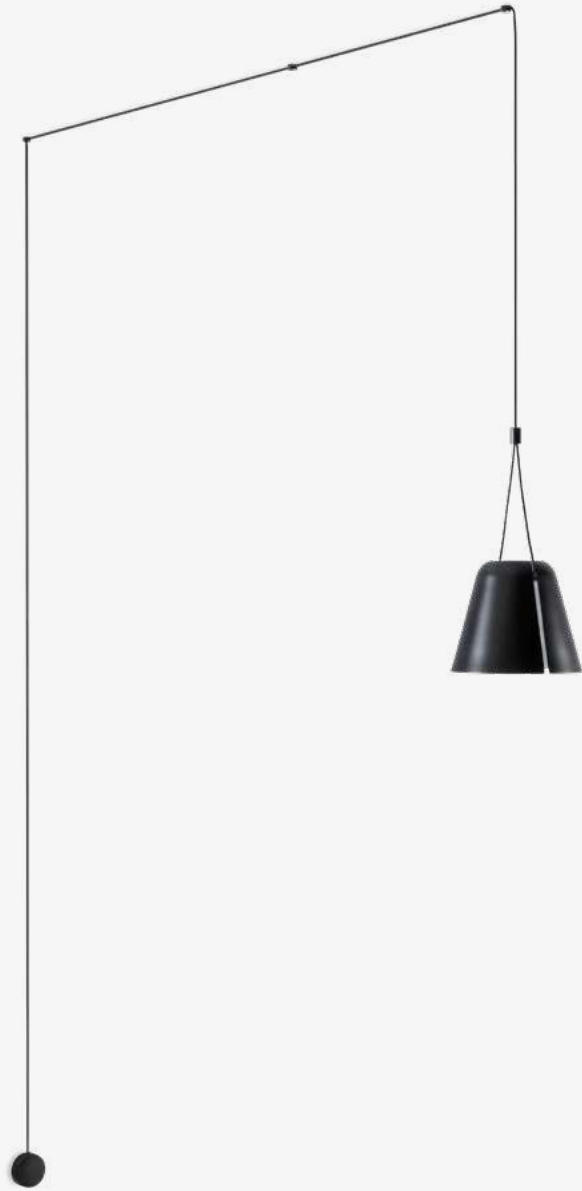

# Attic

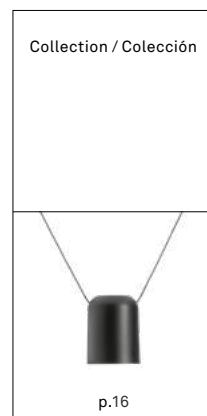



Stylus



1x LED 3,4/7,5W 3000K  
TEC. INFO P.146

Ivy



1x LED 2,2W 3000K  
TEC. INFO P.146

Gloss



1x E27 or 1x E27 + LED 1W 3000K  
TEC. INFO P.149

Bali



1x E27 or 1x E27 + LED 2,1W 3000K  
TEC. INFO P.150

Book



1x LED 2,2W 3000K  
TEC. INFO P.147

Bed



1x LED 2,2W 3000K  
TEC. INFO P.148

Michigan



1x E27 + LED 1W 3000K  
TEC. INFO P.151

Bristol



1x E27 or 1x E27 + LED 2,2W 3000K  
TEC. INFO P.152

Funk



1 x E27  
TEC. INFO P.153

Pipe



2 x GU10  
TEC. INFO P.153

Ges



1 x LED 3/7,2W 3000K  
TEC. INFO P.155

Vintage



1 x 8W 3000K  
TEC. INFO P.156

Kub



1 x 4,3W 3000K  
TEC. INFO P.154

Eclipse



1 x 4,6W 2700K  
TEC. INFO P.154

Duna

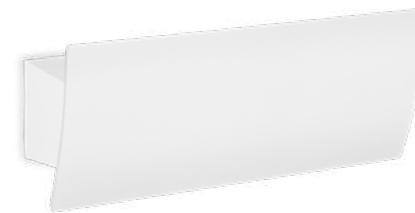

1 x LED 30W 3000K  
TEC. INFO P.157

Room



1 x LED 8,1W 3000K  
TEC. INFO P.158

Table & Floor / Sobremesa y Pie

# Gamma



(ENG) With a minimalist design, it stands out for its excellent finishes and a flexibility that makes it perfect for the hotel sector. With a round base, it is supplied in 4 different finishes.

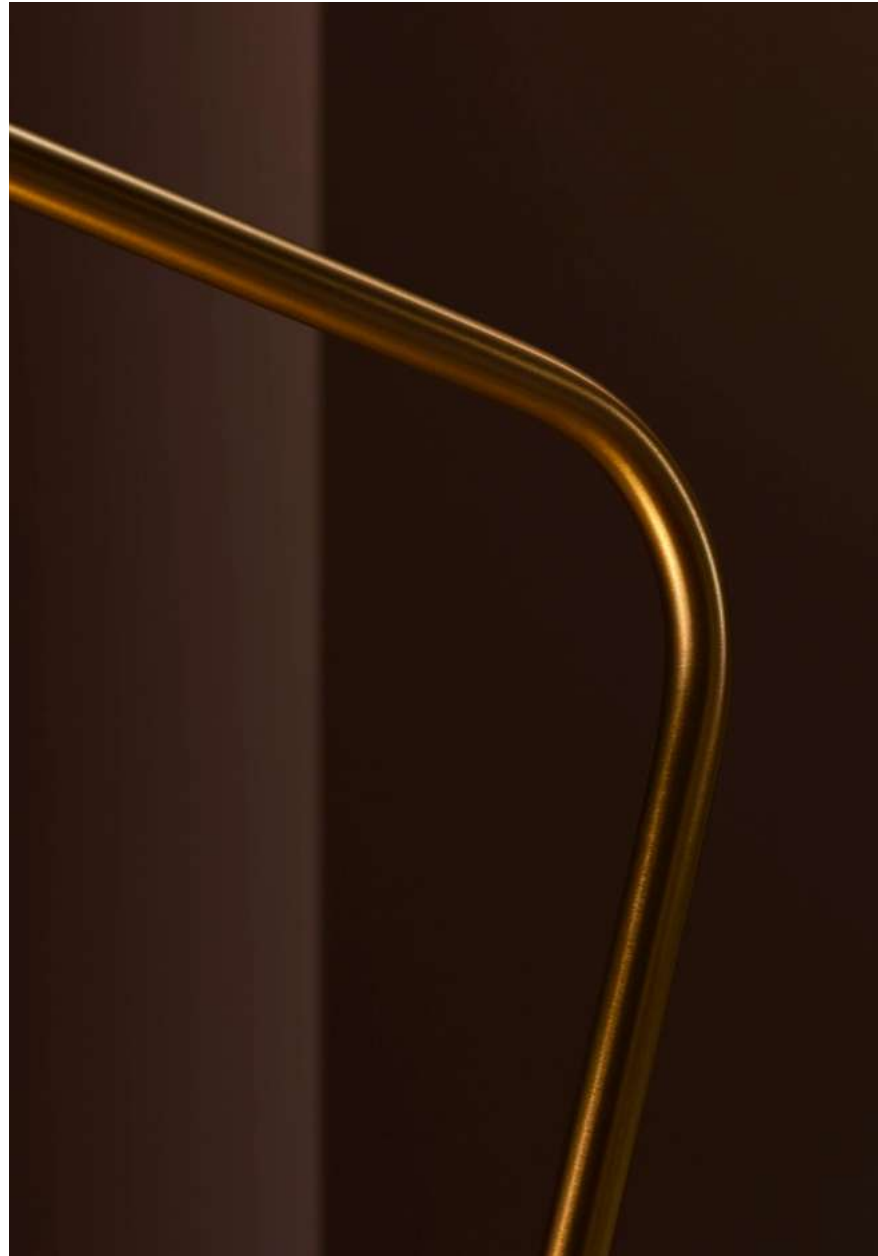

— ENG. The matt gold finish enhances the elegance of this minimalist version of the reading lamp.  
— ESP. El acabado en dorado mate acentúa la elegancia de esta versión minimalista de la luz de escritorio.

(ESP) Con un diseño minimalista, destaca por sus excelentes acabados y una flexibilidad que la hacen perfecta para el sector hotelero. De base redonda, cuenta con mas de 4 acabados.



Collection / Colección



p.36

1 x LED 2,2W 2700K  
TEC. INFO P.159

Table & Floor

Sobremesa y Pie

(ENG) This multifunctional luminaire with a contemporary design is the fruit of the combination of multiple planes with basic geometrical forms. Designed with the mobile phone in mind, all models include a USB port and the table model includes wireless charging technology.

# Elamp



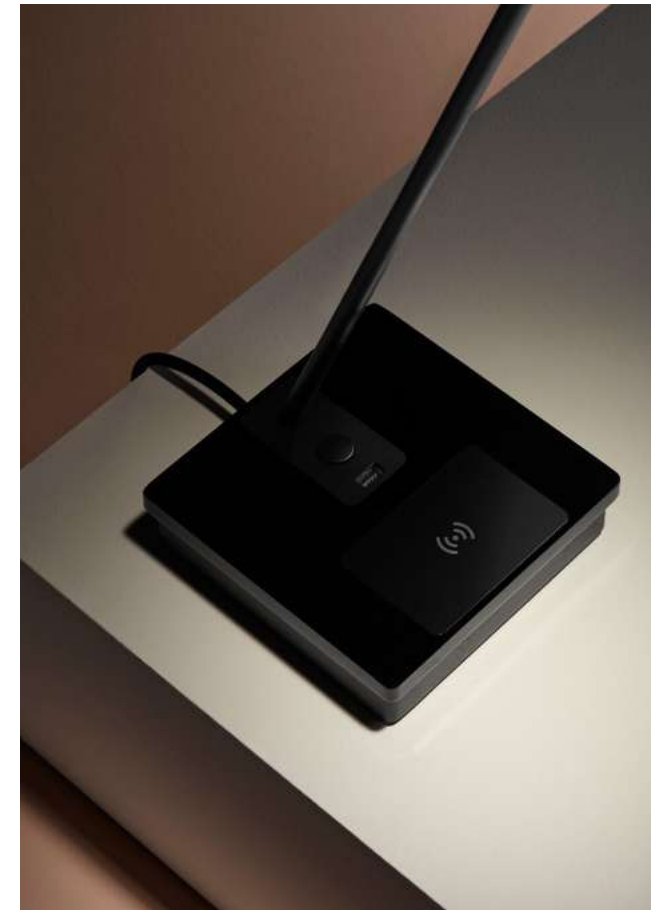

- ENG. Table lamp with a timeless design, ideal as a reading or ambient light.
- ESP. Luz de mesa con diseño atemporal ideal para iluminar cualquier lectura o ambiente.

(ESP) De la unión de múltiples planos con formas geométricas básicas nace esta luminaria multifuncional de diseño contemporáneo. Centrada en el teléfono móvil, incluye USB en todas sus versiones y tecnología de carga inalámbrica en la de sobremesa.



Collection / Colección



p. 44

# Organic

(ENG) Flowers, leaves and other organic elements have inspired the subtle forms of this luminaire with a distinct personality that embodies the icons of the 1950s. It integrates effortlessly into any setting, reflecting the volatile elegance of the natural world.





(ESP) Flores, hojas y otros elementos orgánicos inspiran las formas suaves de una luminaria con marcada personalidad que revive iconos de los años 50 y se integra en el entorno destilando la elegancia volátil del mundo natural.



— ENG. Its distinctive design does not hinder it from blending in with the setting to create warm and elegant atmospheres.

— ESP. Su diseño distintivo no le impide mimetizarse con el contexto para crear ambientes sugerentes y acogedores.

Collection / Colección



1 x E27

TEC. INFO P.160 / P.163

Funk



1 x E27  
TEC. INFO P.160

Elva



1 x 4,7W 3000K  
TEC. INFO P.160

Funk



1 x E27  
TEC. INFO P.163

Vintage

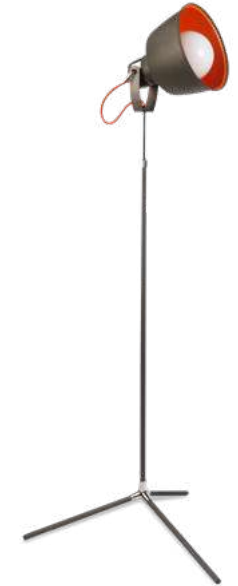

1 x E27  
TEC. INFO P.164

Michigan



1 x E27  
TEC. INFO P.161

Bristol



1 x E27  
TEC. INFO P.162

Michigan



1 x E27  
TEC. INFO P.164

Bristol



1 x E27  
TEC. INFO P.165

Bath / Baño

— ENG. An elegant downlight made of printed glass, synonymous with lighting quality. Thanks to its different finish and format options and its compatibility with the Play Optics modules and accessories, this model fits perfectly into architectural elements.

— ESP. Un elegante downlight de vidrio serigrafiado que es sinónimo de calidad de la luz. Su flexibilidad en acabados y formatos y su compatibilidad con los módulos y accesorios de Play Optics facilitan su plena integración en los elementos de la arquitectura.



# Play Optics



— ENG. A bathroom sconce with a minimalist design and high lumen power. Available in different sizes.

— ESP. Aplique de baño de estética minimalista, diferentes tamaños y alta potencia lumínica.



# Toilet Slim



1 x LED 10,8/22/28,3/37,6W 3000 K  
TEC. INFO P.165

— ENG. A refined lamp with a clean design and a main feature: pressed glass.

— ESP. Una luminaria noble con un diseño limpio y un protagonista claro: el vidrio prensado.



# Vetro



1 x LED 24W 3000K  
TEC. INFO P.166

Architectural Lighting / Iluminación Arquitectónica

# Atom



(ENG) High performance and functionalism with a minimalist and versatile design. These projectors can be completely built in, to emphasise specific elements or simply to shine on their own. The ideal freedom of choice for shops, restaurants and hotels.



- ENG. Optimal control of the light and minimal residual halo, thanks to its top-quality components.
- ESP. Permite un óptimo control de la luz y un mínimo halo residual gracias a sus componentes de la máxima calidad.

(ESP) Altas prestaciones, funcionalidad y un diseño minimalista y versátil. Estos proyectores pueden quedar completamente integrados, enfatizar elementos concretos o brillar por sí solos. Una libertad de elección ideal para espacios comerciales, restaurantes y hoteles.



# Low Voltage

( ENG ) This multi-purpose system, consisting of a magnetic profile and 48V of power, is compatible with projectors, hanging pieces and linear pieces, giving the designer total freedom to adjust and move the points of light in keeping with the changing lighting demands of each specific space.

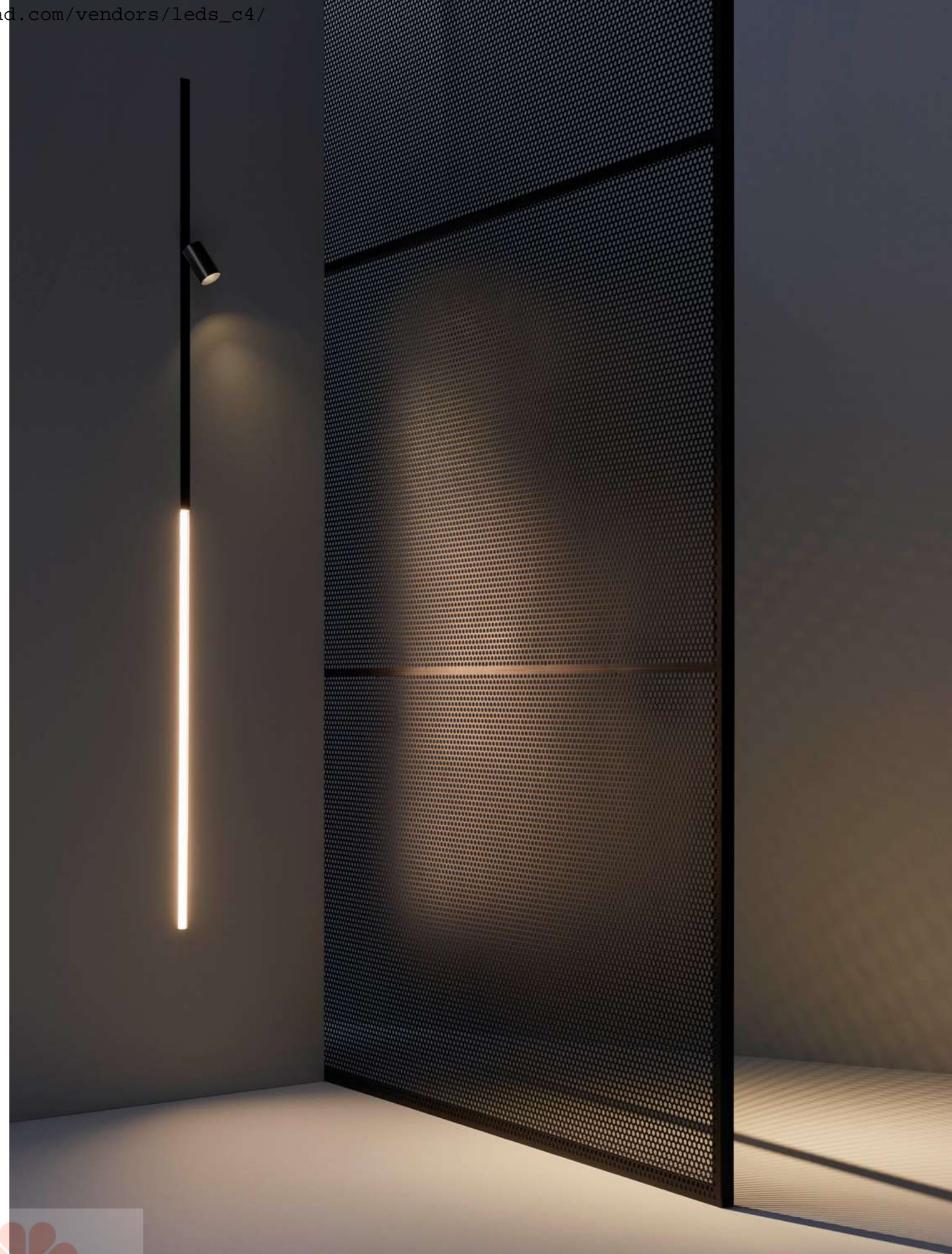



— ENG. Designed for adaptable multi-purpose rooms that require precise and well-defined lighting.  
— ESP. Pensado para ambientes variables que requieren una iluminación precisa y definida.

(ESP) Este sistema polivalente, formado por un perfil magnético, alimentado a 48V, compatible con proyectores, colgantes o lineales aporta al diseñador libertad total para ajustar y mover los puntos de luz según las cambiantes exigencias de iluminación únicas de cada espacio.

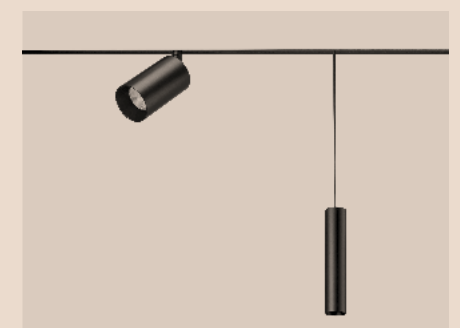

— ENG. Attom low voltage and Vela low voltage.  
— ESP. Attom low voltage y Vela low voltage.

# Play Deco Optics



(ENG) All the efficacy, optical control and easy installation of the Play Optics family, with countless decorative options to personalize the installation. The ideal point of balance between functionalism and aesthetics.



— ENG. Its versatility in terms of finishes and colours is particularly special, with options including gold colour with textured paint.

— ESP. Su versatilidad en acabados y colores tiene como punto diferencial el dorado con pintura texturizada.

(ESP) Toda la eficiencia, el control óptico y la facilidad de instalación de la familia Play Optics con multitud opciones de personalización a nivel decorativo. El punto de equilibrio ideal entre funcionalidad y estética.



1 X LED 7/13/18W 2700/3000/4000K  
TEC. INFO P.184

(ENG) The most flexible and functional product family on the market increases its power, with an 18W module for spacious rooms with high ceilings or those that require more lighting. The new Narrow 10° optics feature makes it possible to accentuate the theatrics on stages, with several different points of light.

# Play Optics





- ENG. Compatible with all existing structures and accessories, allowing designers to find the ideal lighting solution for each space.
- ESP. Compatible con todos los marcos y accesorios existentes para encontrar la solución lumínica idónea para cada espacio.

(ESP) La familia más flexible y funcional del mercado aumenta su potencia con un módulo de 18W para espacios amplios con mucha altura o que requieren más luminosidad. La nueva óptica Narrow 10° permite acentuar la teatralidad de las escenas con varios puntos de luz.

## Architectural Lighting

## Iluminación Arquitectónica

(ENG) The downlights in this collection are unique for their increased efficiency, reaching 113 lm/W, and their easy exchange of lenses. Moreover, the combined technology of polycarbonate lenses and CREE LEDs makes for optimal halo control.

(ESP) Los downlights de esta colección destacan por una mayor eficiencia hasta los 113 lm/W y un fácil intercambio de lentes. Gracias a la combinación de la tecnología de lentes de policarbonato y los LED CREE, ofrecen un control óptimo del halo de luz.



# Mini Play

1 X LED 3W 2700/3000/4000K  
TEC. INFO P.195



# Luno

(ENG) With a cylindrical shape and refined lines, this source of downlighting can be installed on a surface, it can be built-in and it can be suspended. It has a life cycle of 50,000 hours and offers countless options to illuminate large spaces: from auditoriums to hotel lobbies.





(ESP) De forma cilíndrica y líneas puras, esta fuente de luz descendente puede instalarse en superficie, empotrada o en suspensión. Tiene una vida útil de 50.000 horas y multitud de posibilidades para iluminar grandes espacios: desde auditorios a lobbies de hotel.



— ENG. Available in four different diameters, making it ideal for combinations.

— ESP. Disponible en cuatro diámetros distintos que la hacen ideal para combinaciones.

# Taglio di luce

(ENG) A linear system that provides architects and designers with the raw materials to draw a concept into the space. Thanks to its versatility and subtlety, the light blends into the room, creating inventive linear compositions with lighting effects on walls and ceilings.

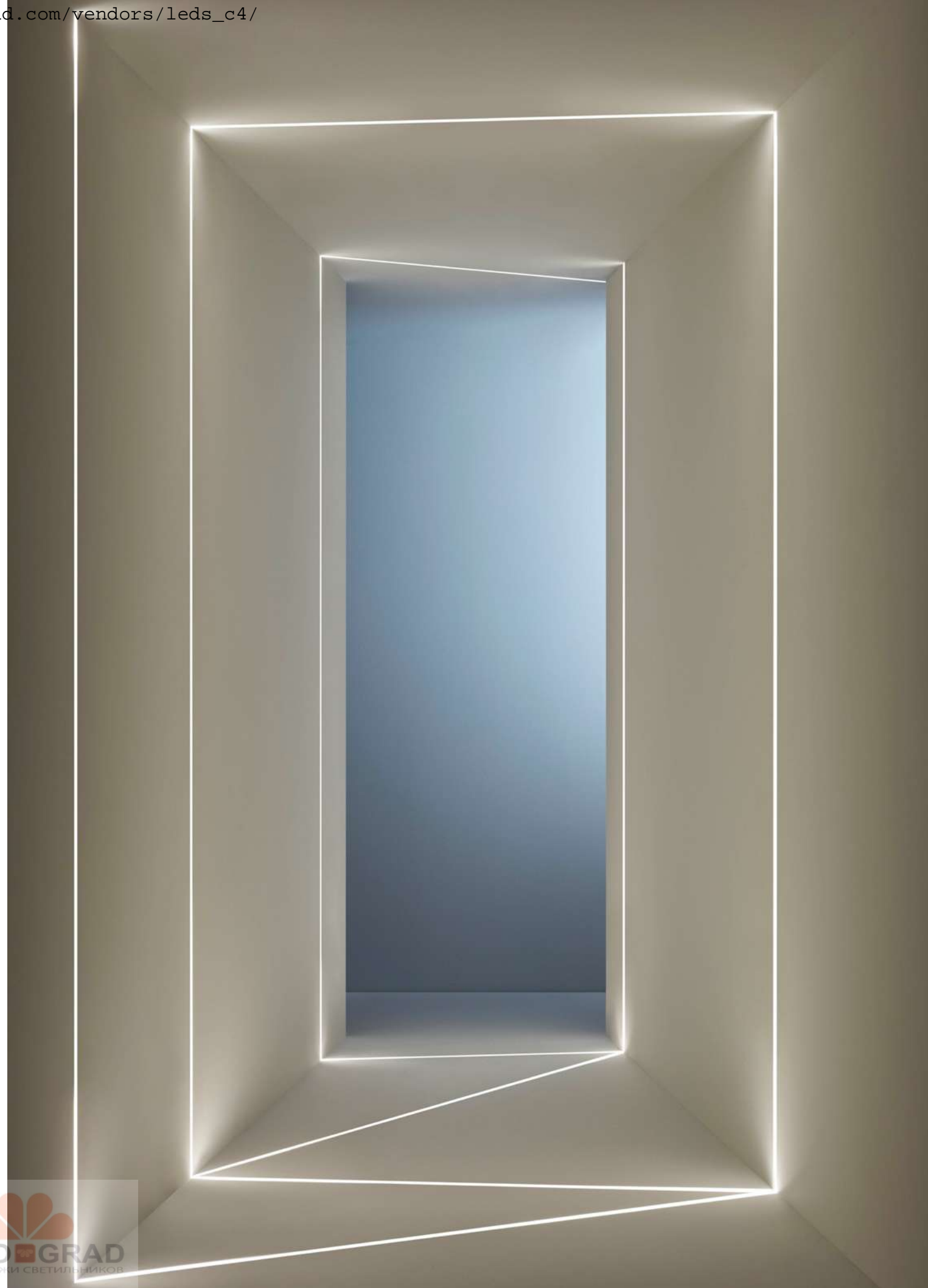

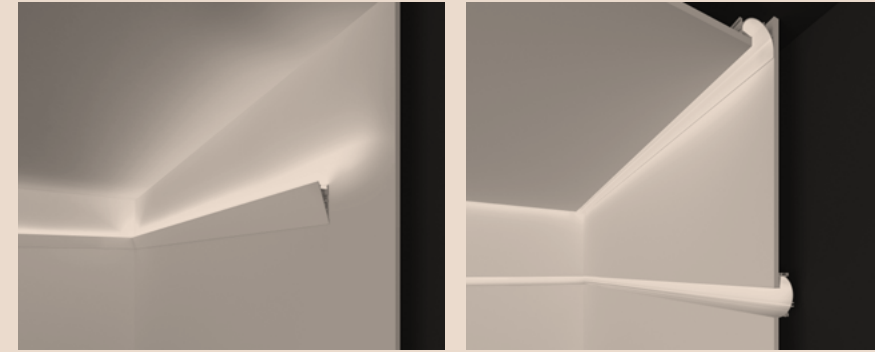

- ENG. The perfect joints of the lighting structures make it possible to create the lighting drawing or effect of your dreams.
- ESP. La perfecta unión de las estructuras luminicas permite conseguir el dibujo o efecto de luz soñado.

(ESP) Un sistema lineal que ofrece a arquitectos y diseñadores la materia prima con la que pintar un concepto en el espacio. Gracias a su versatilidad y sutileza, la luz se funde en el entorno creando ingeniosas composiciones lineales con efectos y juegos de luz en paredes y techos.

TAGLIO DI LUCE DIRECT

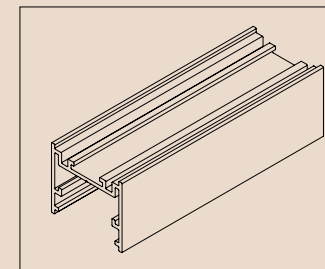

TAGLIO DI LUCE INDIRECT

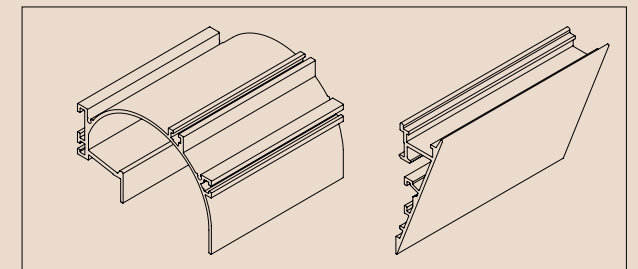

# Maai

(ENG) Technology and aesthetics go hand in hand in this versatile wall light. With its lightweight and well-balanced structure, it's easily adaptable to any space. It combines two diffusers: one inner micro engraved diffuser to maximise uniformity and one outer micro vertices diffuser to provide optimum visual comfort.



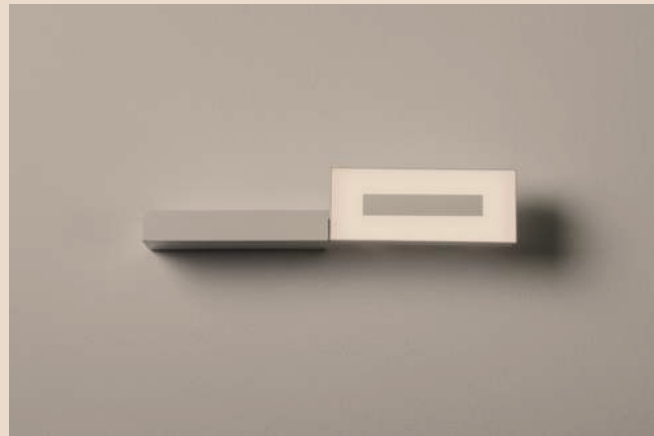
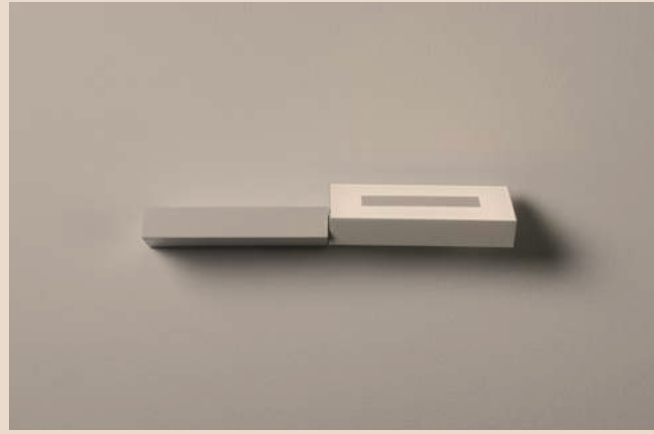
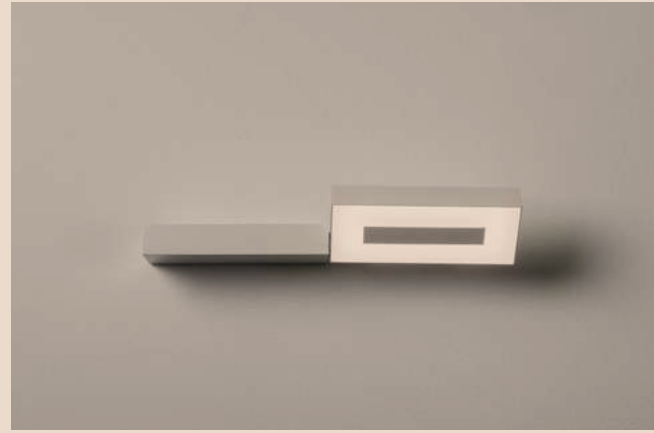
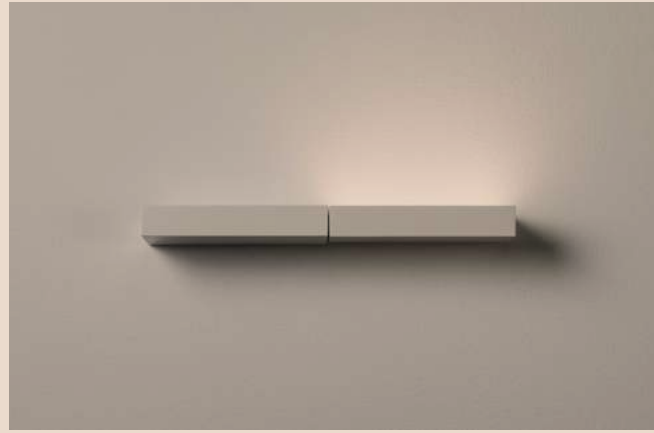

(ESP) Tecnología y estética van de la mano en un aplique versátil de estructura ligera y equilibrada, fácilmente adaptable a cualquier espacio. Combina dos difusores, uno interior microgravado, que maximiza la uniformidad, y uno exterior en microvértices, que proporciona un óptimo confort visual.

— ENG. Its 350° adjustable base means you can angle the light to illuminate anywhere in the space.

— ESP. Su eje ajustable en 350° permite orientar la fuente de luz para iluminar cualquier punto de la estancia.

1 x LED 11/24W 3000/4000K  
TEC. INFO P.210

## Architectural Lighting

## Iluminación Arquitectónica

(ENG) With this flexible and resistant LED strip, light essentially becomes a form of ink and the surface becomes a canvas. This model provides impeccable continuous lighting and enables designers and architects to draw shapes that were previously impossible to achieve.

# Asai



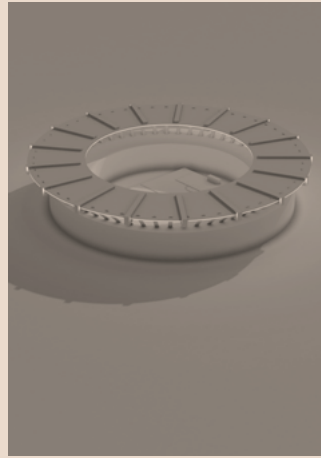

— ENG. Available in two types of curves: the side bend, with flexibility along the vertical axis; and the top bend, with flexibility along the horizontal axis.

— ESP. Disponible en dos tipologías de curvado: side bend, flexible en el eje vertical y top bend, en el eje horizontal.

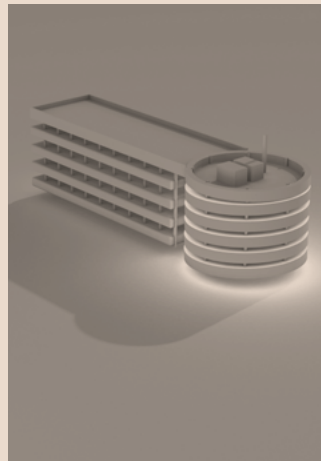

(ESP) Esta tira led de cuerpo flexible y resistente convierte la luz en tinta y las superficies en lienzos. Aporta una continuidad lumínica impecable y permite a diseñadores y arquitectos dibujar formas en el espacio hasta el momento imposibles de conseguir.

LED 14W x mt 3000K  
TEC. INFO P.211

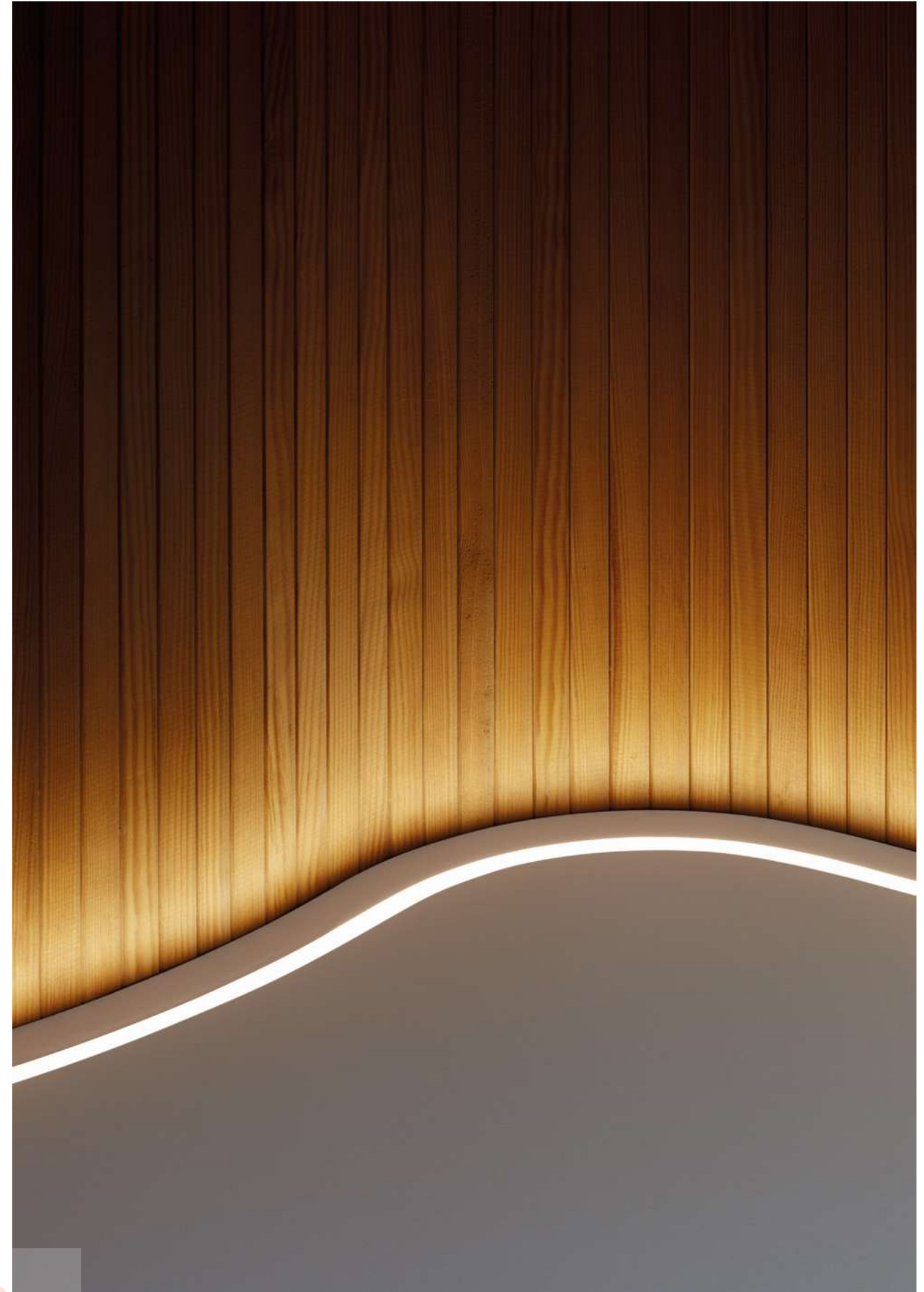

Technical Information / Información Técnica



**Veneto** N

- 14-DO
- 60-DO\*
- DL-DO\*



\* Please contact our sales team for conditions and delivery times.  
\* Consultar condiciones y plazos de entrega a nuestro equipo comercial.

BODY MAT AL / ST   DIF MAT PMMA   IP20   4   60000h L90 B10   2 MacAdam    

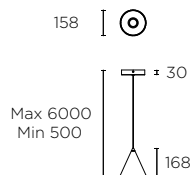
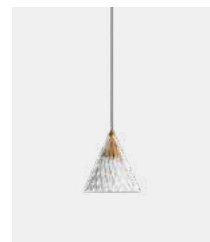

LED CREE											
K	CRI	W	Real lm	V							
2700	80	6,7	452	100-240	-	-	00-7588	-	14-DO	60-DO	DL-DO
				220-240	MAINS LC		00-7589				
100-240V 50-60Hz											

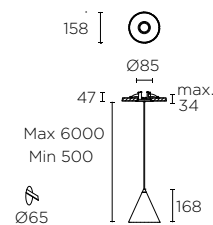

LED CREE											
K	CRI	W	Real lm	V							
2700	80	6,7	452	100-240	-	-	00-7590	-	14-DO		
				220-240	MAINS LC		00-7591				
65    max. 30mm    100-240V 50-60Hz											

**Veneto** N

- 14-DO
- 60-DO\*
- DL-DO\*



\* Please contact our sales team for conditions and delivery times.  
\* Consultar condiciones y plazos de entrega a nuestro equipo comercial.

BODY MAT AL / ST   DIF MAT PMMA   IP20   1   50000h L70 B30   3 MacAdam    

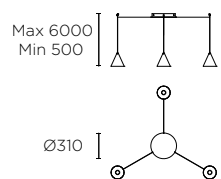

LED SAMSUNG											
K	CRI	W	Real lm	V							
2700	80	15	804	-	-	-	15-7590	-			
				DALI	-	-	15-7596	-	14-DO	60-DO	DL-DO
				0...10V			15-7602				
100-240V 50-60Hz											

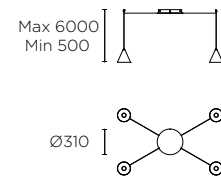

LED SAMSUNG											
K	CRI	W	Real lm	V							
2700	80	20	1072	-	-	-	15-7591	-	14-DO	60-DO	DL-DO
				DALI	-	-	15-7597	-			
				0...10V			15-7603				
100-240V 50-60Hz											

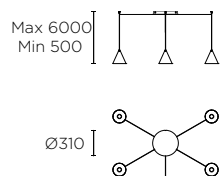

LED SAMSUNG											
K	CRI	W	Real lm	V							
2700	80	25	1340	-	-	-	15-7592	-	14-DO	60-DO	DL-DO
				DALI	-	-	15-7598	-			
				0...10V			15-7604				
100-240V 50-60Hz											

**Attic** N

\* Please contact our sales team for conditions and delivery times.  
\* Consultar condiciones y plazos de entrega a nuestro equipo comercial.

BODY MAT AL         1  

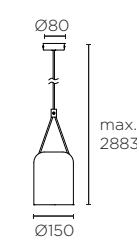
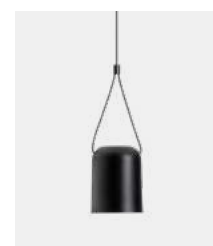

E-27 Hal - Fluo - Led / max. L 120mm Ø 100mm										
W										
23 max.	00-7388	-	05-14	05-05	05-DL					

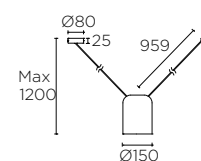

E-27 Hal - Fluo - Led / max. L 120mm Ø 100mm										
W										
23 max.	00-7392	-	05-14	05-05	05-DL					

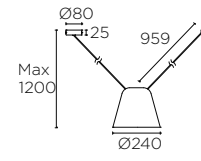
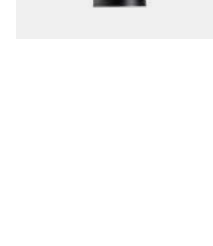

E-27 Hal - Fluo - Led / max. L 120mm Ø 100mm										
W										
23 max.	00-7393	-	05-14	05-05	05-DL					

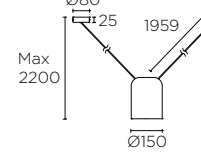

E-27 Hal - Fluo - Led / max. L 120mm Ø 100mm										
W										
23 max.	00-7390	-	05-14	05-05	05-DL					

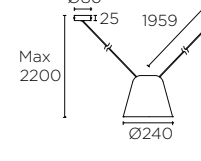
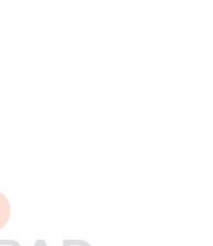

E-27 Hal - Fluo - Led / max. L 120mm Ø 100mm										
W										
23 max.	00-7391	-	05-14	05-05	05-DL					

**E-27** Hal - Fluo - Led / max. L 120mm Ø 100mm

**W**     \*

2 x 23 max. **00-7396 - 05-14 05-05 05-DL**

**E-27** Hal - Fluo - Led / max. L 120mm Ø 100mm

**W**     \*

2 x 23 max. **00-7394 - 05-14 05-05 05-DL**

**E-27** Hal - Fluo - Led / max. L 120mm Ø 100mm

**W**     \*

2 x 23 max. **00-7397 - 05-14 05-05 05-DL**

**E-27** Hal - Fluo - Led / max. L 120mm Ø 100mm

**W**     \*

2 x 23 max. **00-7395 - 05-14 05-05 05-DL**

**E-27** Hal - Fluo - Led / max. L 120mm Ø 100mm

**W**     \*

3 x 23 max. **00-7400 - 05-14 05-05 05-DL**

**E-27** Hal - Fluo - Led / max. L 120mm Ø 100mm

**W**     \*

3 x 23 max. **00-7398 - 05-14 05-05 05-DL**

**E-27** Hal - Fluo - Led / max. L 120mm Ø 100mm

**W**     \*

3 x 23 max. **00-7401 - 05-14 05-05 05-DL**

**E-27** Hal - Fluo - Led / max. L 120mm Ø 100mm

**W**     \*

3 x 23 max. **00-7399 - 05-14 05-05 05-DL**

**E-27** Hal - Fluo - Led / max. L 120mm Ø 100mm

**W**     \*

4 x 23 max. **00-7404 - 05-14 05-05 05-DL**

**E-27** Hal - Fluo - Led / max. L 120mm Ø 100mm

**W**     \*

4 x 23 max. **00-7402 - 05-14 05-05 05-DL**

**E-27** Hal - Fluo - Led / max. L 120mm Ø 100mm

**W**     \*

4 x 23 max. **00-7405 - 05-14 05-05 05-DL**

**E-27** Hal - Fluo - Led / max. L 120mm Ø 100mm

**W**     \*

4 x 23 max. **00-7403 - 05-14 05-05 05-DL**

Collection / Colección



Khoi

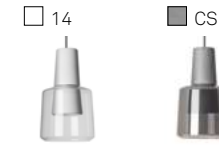

BODY MAT AL DIF MAT GLA 14 CS 50000h L70 B30 2 MacAdam

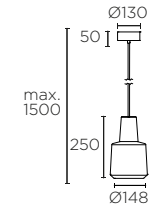

**LED** CREE

K	CRI	W	Real lm
3000	80	19,5	907

**00-4037 - 14 - 37**  
**CS - 12**

100-240V 50-60Hz

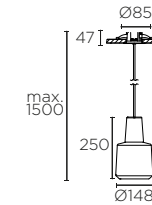

**LED** CREE

K	CRI	W	Real lm
3000	80	19,5	907

**00-5980 - 14 - 37**  
**CS - 12**

Ø65 max.30  
100-240V 50-60Hz

Contrast



BODY MAT ST / CON / WOOD 93 DC 1

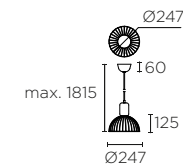

**E-27** Hal - Fluo - Led

**W**      \*

60 max. **00-6415 - DC 93 - 05 F5 14 J6**

100-240V 50-60Hz

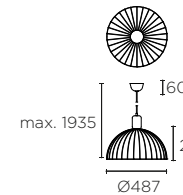

**E-27** Hal - Fluo - Led

**W**      \*

60 max. **00-6414 - DC 93 - 05 F5 14 J6**

100-240V 50-60Hz

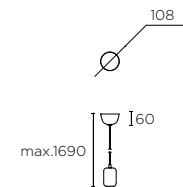

**E-27** Hal - Fluo - Led

**W**     \*

60 max. **00-7365 - DC 93 - 05**

100-240V 50-60Hz

Collection / Colección



\* Please contact our sales team for conditions and delivery times.  
\* Consultar condiciones y plazos de entrega a nuestro equipo comercial.

# Cherry

\* Please contact our sales team for conditions and delivery times.  
\* Consultar condiciones y plazos de entrega a nuestro equipo comercial.

BODY MAT ST DIF MAT PMMA 60000h L90 B10 2 MacAdam

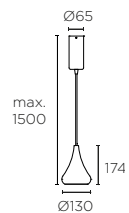

LED CREE													
K	CRI	W	Real lm	V									
3000	80	8,6	859	100-240	-	00-5346	-	F5-F5	14-14	34-34	60-60	Z5-Z5	J6-J6
				220-240	MAINS LC	00-5347							
2700	80	8,6	859	100-240	-	00-5574	-	F5-F5	14-14	34-34	60-60	Z5-Z5	J6-J6
				220-240	MAINS LC	00-5575							

LED CREE													
K	CRI	W	Real lm	V									
3000	80	8,6	859	100-240	-	00-5977	-	F5-F5	14-14	34-34	60-60	Z5-Z5	J6-J6
				220-240	MAINS LC	00-5995							
2700	80	8,6	859	100-240	-	00-5989	-	F5-F5	14-14	34-34	60-60	Z5-Z5	J6-J6
				220-240	MAINS LC	00-5990							

50-60Hz Ø65 max.30

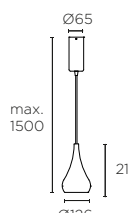

LED CREE													
K	CRI	W	Real lm	V									
3000	80	8,6	859	100-240	-	00-5348	-	14-14	34-34	F5-F5	60-60	Z5-Z5	J6-J6
				220-240	MAINS LC	00-5349							
2700	80	8,6	859	100-240	-	00-5576	-	14-14	34-34	F5-F5	60-60	Z5-Z5	J6-J6
				220-240	MAINS LC	00-5577							

LED CREE													
K	CRI	W	Real lm	V									
3000	80	8,6	859	100-240	-	00-5978	-	14-14	34-34	F5-F5	60-60	Z5-Z5	J6-J6
				220-240	MAINS LC	00-5996							
2700	80	8,6	859	100-240	-	00-5991	-	14-14	34-34	F5-F5	60-60	Z5-Z5	J6-J6
				220-240	MAINS LC	00-5992							

50-60Hz Ø65 max.30

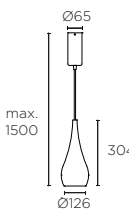

LED CREE													
K	CRI	W	Real lm	V									
3000	80	8,6	859	100-240	-	00-5350	-	34-34	14-14	F5-F5	60-60	Z5-Z5	J6-J6
				220-240	MAINS LC	00-5351							
2700	80	8,6	859	100-240	-	00-5578	-	34-34	14-14	F5-F5	60-60	Z5-Z5	J6-J6
				220-240	MAINS LC	00-5579							

LED CREE													
K	CRI	W	Real lm	V									
3000	80	8,6	859	100-240	-	00-5979	-	34-34	14-14	F5-F5	60-60	Z5-Z5	J6-J6
				220-240	MAINS LC	00-5997							
2700	80	8,6	859	100-240	-	00-5993	-	34-34	14-14	F5-F5	60-60	Z5-Z5	J6-J6
				220-240	MAINS LC	00-5994							

50-60Hz Ø65 max.30

# Sugar

BODY MAT AL DIF MAT ACR 50000h L70 B30 2 MacAdam COMPATIBLE CASAMBI

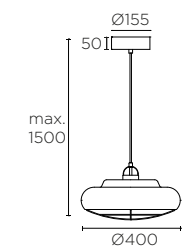

LED CREE												
K	CRI	W	Real lm	V								
2700	80	26,6	1575	100-240	-	00-5297	-	14-23	Z5-23			
				220-240	MAINS LC	00-5580						

LED CREE												
K	CRI	W	Real lm	V								
2700	80	26,6	1575	100-240	-	00-5984	-	14-23	Z5-23			
				220-240	MAINS LC	00-5998						

50-60Hz Ø65 max.30

# Caprice

\* Please contact our sales team for conditions and delivery times.  
\* Consultar condiciones y plazos de entrega a nuestro equipo comercial.

BODY MAT ST DIF MAT ACR 3 MacAdam COMPATIBLE CASAMBI

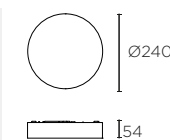

LED												
K	CRI	W	Real lm	V								
3000	80	24	1218	MAINS LC	↔CASAMBI	15-6196	-	14-M1	60-M1	Z5-M1	DL-M1	J6-M1

50000h L70 B50 220-240V 50-60Hz

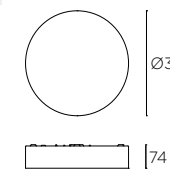
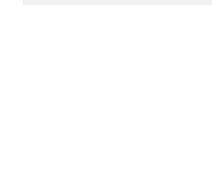

LED												
K	CRI	W	Real lm	V								
3000	80	32	1471	MAINS LC	↔CASAMBI	15-6197	-	14-M1	60-M1	Z5-M1	DL-M1	J6-M1

50000h L70 B50 220-240V 50-60Hz

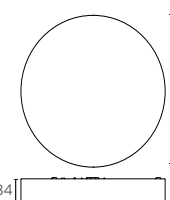

LED												
K	CRI	W	Real lm	V								
3000	80	27,8	3356	MAINS LC	↔CASAMBI	15-6433	-	14-M1	60-M1	Z5-M1	DL-M1	J6-M1

50000h L70 B30 220-240V 50-60Hz

Not included / no incluido

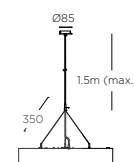

Suspension kit / Kit suspensión 71-6196 - 14 - 14

# Stylus

BODY MAT AL 50000h L70 B30 3 MacAdam

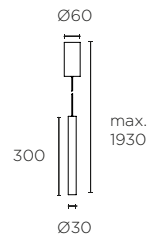
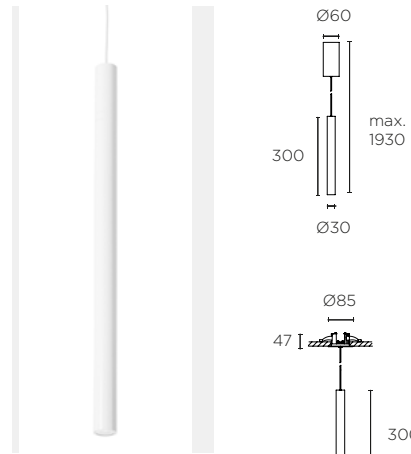

LED						
K	CRI	W	Real lm			
3000	82	7,5	584	00-5478	- 14-14	05-05

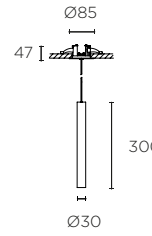

LED						
K	CRI	W	Real lm			
3000	82	7,5	584	00-5981	- 14-14	05-05

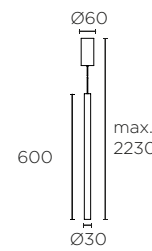

LED						
K	CRI	W	Real lm			
3000	82	7,5	584	00-5479	- 14-14	05-05

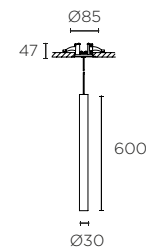

LED						
K	CRI	W	Real lm			
3000	82	7,5	584	00-5982	- 14-14	05-05

## Collection / Colección



P. 146



P. 146

# Raw

BODY MAT ST DIF MAT GLA 50000h L70 B30 2 MacAdam

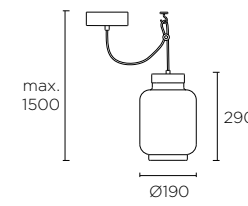

LED CREE						
K	CRI	W	Real lm			
3000	80	14	1106	00-5448	- CI - 08	

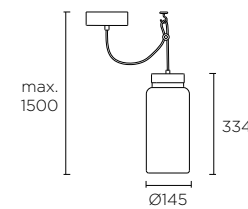

LED CREE						
K	CRI	W	Real lm			
3000	80	14	1253	00-5449	- CI - 15	

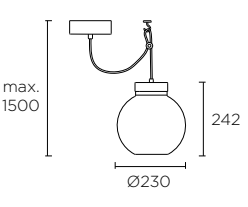
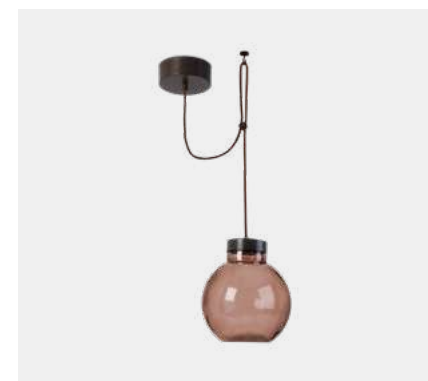

LED CREE						
K	CRI	W	Real lm			
3000	80	14	650	00-5450	- CI - 18	

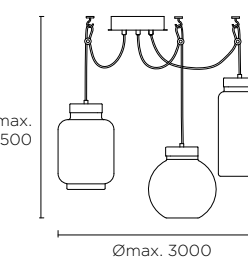
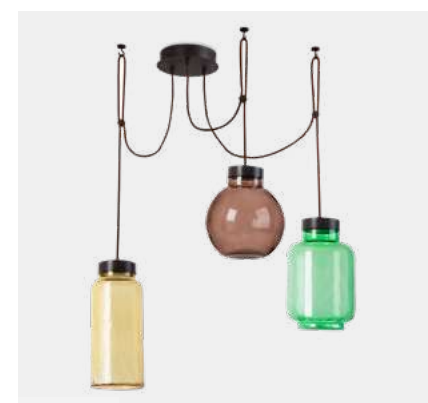

LED CREE						
K	CRI	W	Real lm			
3000	80	38,5	3009	00-5451	- CI - E7	

# Funk

BODY MAT ST 355° ↻ 90°

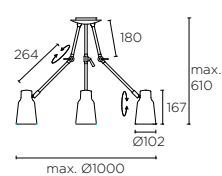
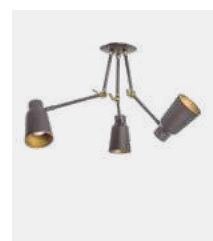

<b>E-27</b> Hal - Fluo - Led / max. L 125mm Ø 80mm			
<b>W</b>		CI-23	
3 x 40 max.	<b>20-4755</b>	- CI -	<b>23</b>

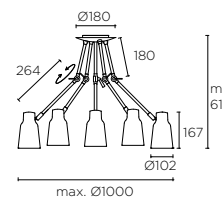

<b>E-27</b> Hal - Fluo - Led / max. L 125mm Ø 80mm			
<b>W</b>		CI-23	
5 x 40 max.	<b>20-4756</b>	- CI -	<b>23</b>

Collection / Colección



# Eclipse

BODY MAT CON

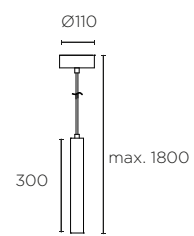

<b>LED</b> CREE			
<b>K</b>	<b>CRI</b>	<b>W</b>	<b>Real lm</b>
2700	80	7	118
<b>00-5697 - 05 - DC</b>			
	g	50000h	2 MacAdam
		<b>L90 B10</b>	
			100-240V 50-60Hz

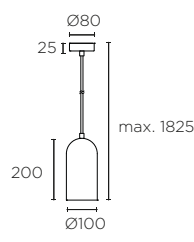

<b>E-27</b> Led / max. L 140mm Ø 60mm			
<b>W</b>			
20 max.	<b>00-5678</b>	- 05 -	<b>DC</b>

Collection / Colección



P.154

# Pipe

BODY MAT AL

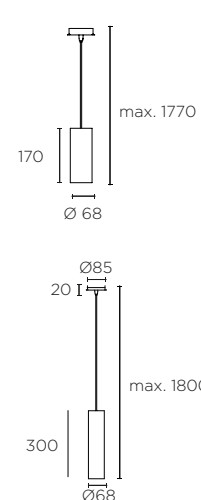

<b>GU10</b> Hal - Led			
<b>W</b>			
50 max.	<b>00-0073</b>	- 14-05	<b>05-23 Z5-Z5 DL-DL J6-J6</b>



<b>GU10</b> Hal - Led			
<b>W</b>			
50 max.	<b>00-5456</b>	- 14-05	<b>05-23 Z5-Z5 DL-DL J6-J6</b>



Not included / no incluido

	Ø65 max. 30	Ceiling rose for embedding Florón para empotrar	Compatible / Compatible 00-5456	<b>71-5456</b>	- 14 -	<b>14</b>
		Track connector Conector de carril	Compatible / Compatible 00-0073	<b>71-5967</b>	- 14 -	<b>14</b>
				<b>71-2232</b>	- 14 -	<b>14</b>



<b>71-0073</b>	-	<b>14-14</b>	<b>05-05</b>	<b>Z5-Z5 DL-DL J6-J6</b>

Collection / Colección



P.153

\* Please contact our sales team for conditions and delivery times.  
\* Consultar condiciones y plazos de entrega a nuestro equipo comercial.

# Vintage

BODY MAT ST / AL DIF MAT GLA 50000h L70 B30 2 MacAdam

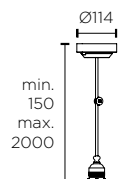

LED CREE					
K	CRI	W	Real lm		
3000	80	8,3	756	71-4820	- 50 - 50

16 100-240V 50-60Hz

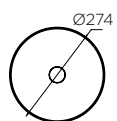

71-4821	- CU-CU	-	-	14-14	60-60	Z5-Z5	DL-DL	J6-J6
---------	---------	---	---	-------	-------	-------	-------	-------

8

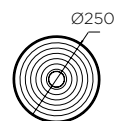

71-4824	-	-	20-20	CI-CI	14-14	60-60	Z5-Z5	DL-DL	J6-J6
---------	---	---	-------	-------	-------	-------	-------	-------	-------

8



71-4940	-	-	-	CI-CI	14-14	60-60	Z5-Z5	DL-DL	J6-J6
---------	---	---	---	-------	-------	-------	-------	-------	-------

8



71-4825	-	-	-	CI-CI	14-14	60-60	Z5-Z5	DL-DL	J6-J6
---------	---	---	---	-------	-------	-------	-------	-------	-------

8

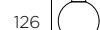

71-4817	-	F1-F1							
---------	---	-------	--	--	--	--	--	--	--

8



71-4818	-	F1-F1							
---------	---	-------	--	--	--	--	--	--	--

8

## Collection / Colección



P. 156

P. 156

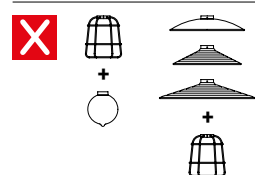

# Vintage

BODY MAT ST 4 GLOBE 20W

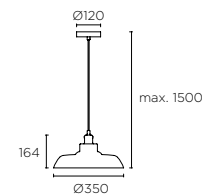
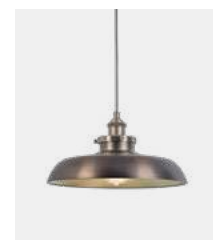

E-27	Hal - Fluo - Led / max. L 130mm Ø 75mm
W	
100 max.	00-4851 - E4 - 19

## Not included / no incluido



Ø65 max. 30 Ceiling rose for embedding Florón para empotrar 71-4851 - 14 - 14



Track connector Conector de carril 71-2232 - 14 - 14

# Vintage

BODY MAT ST 4

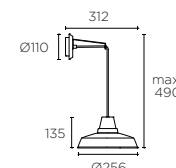
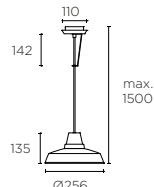

E27	Hal - Fluo - Led max. L 135mm Ø 80mm
W	
60 max.	00-5669 - 21-16 S4-CG



# Vintage

BODY MAT ST 3 GLOBE 20W

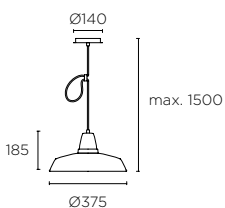

E-27	Hal - Fluo - Led / max. L 140mm Ø 80mm
W	
100 max.	00-1799 - S4-CG

## Not included / no incluido



Ø65 max. 30 Ceiling rose for embedding Florón para empotrar 71-1799 - 14 - 14



Track connector Conector de carril 71-2232 - 14 - 14

## Vintage

BODY MAT ST 2 RECOM BULB GLOBE 20W

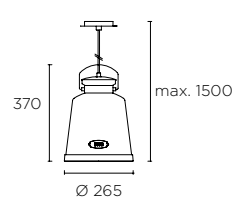

<b>E-27</b> Hal - Fluo - Led / max. L 240mm Ø 220mm
<b>W</b>
100 max. <b>00-0253 - S4-CC</b>

Not included / no incluido

	Ceiling rose for embedding Florón para empotrar	<b>71-0253 - 14 - 14</b>
	Track connector Conector de carril	<b>71-2232 - 14 - 14</b>

## Vintage

BODY MAT ST 4 RECOM BULB GLOBE 20W

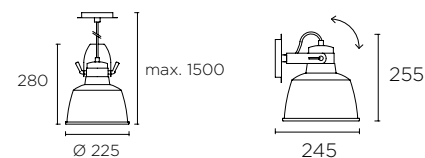
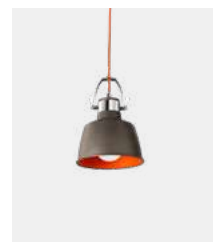

<b>E27</b> Hal - Fluo - Led max. L 175mm Ø 85mm
<b>W</b>
60 max. <b>00-0240 - 21-Z5</b>

Not included / no incluido

	Ceiling rose for embedding Florón para empotrar	<b>71-0240 - 14 - 14</b>
	Track connector Conector de carril	<b>71-2232 - 14 - 14</b>

Collection / Colección



P.164

## Gamma

14-14  81-14  14-14  81-14



BODY MAT AL SHADE MAT COT 50000h L90 B10 3 MacAdam 180° 90°

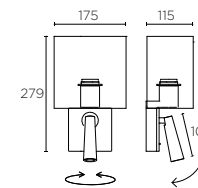

<b>LED</b> CREE + E27 / max. L 84mm Ø 45mm					
<b>K</b>	<b>CRI</b>	<b>W</b>	<b>Real lm</b>	<b>▲</b>	
2700	80	60 max. 2,2	137	25°	<b>05-6422 - 14 - 14</b>
100-240V 50-60Hz					

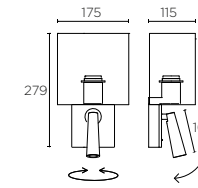

<b>LED</b> CREE + E27 / max. L 84mm Ø 45mm					
<b>K</b>	<b>CRI</b>	<b>W</b>	<b>Real lm</b>	<b>▲</b>	
2700	80	60 max. 2,2	137	25°	<b>05-6423 - 14 - 14</b>
100-240V 50-60Hz					

## Gamma

BODY MAT AL 27 42000h L90 B10 3 MacAdam 180° 90°

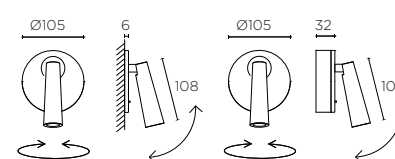

<b>LED</b> CREE					
<b>K</b>	<b>CRI</b>	<b>W</b>	<b>Real lm</b>	<b>▲</b>	
2700	80	2,2	137	25°	<b>05-6421 - 14-14 81-81 Z5-Z5 DN-DN</b>
100-240V 50-60Hz					



Double installation: recessed / surface  
Doble instalación: empotrado/superficie

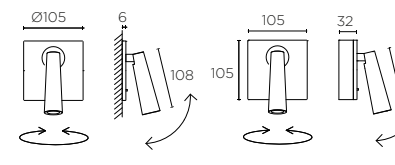

<b>LED</b> CREE					
<b>K</b>	<b>CRI</b>	<b>W</b>	<b>Real lm</b>	<b>▲</b>	
2700	80	2,2	137	25°	<b>05-6420 - 14-14 81-81 Z5-Z5 DN-DN</b>
100-240V 50-60Hz					



05-6421-14-81



05-6421-DN-Z5



05-6420-Z5-81



05-6420-14-DN

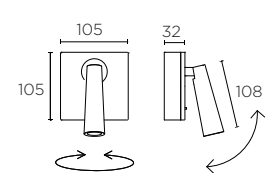
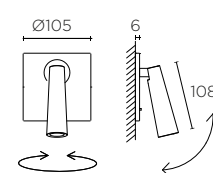
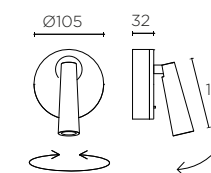
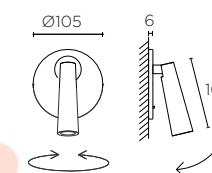

**LED CREE**

K	CRI	W	Real lm	▲
2700	80	2,2	137	25°

05-6421 - 14 81 Z5 DN - 14 81 Z5 DN

100-240V 50-60Hz

**LED CREE**

K	CRI	W	Real lm	▲
2700	80	2,2	137	25°

05-6420 - 14 81 Z5 DN - 14 81 Z5 DN

100-240V 50-60Hz

**Readme** N

14 81

BODY MAT AL DIF MAT PMMA IP20 6 60000h L80 B20 2 MacAdam 355° 90°

**LED CREE**

K	CRI	W	Real lm
3000	80	4,8	388

05-7587 - 14 81 - M3

100-240V 50-60Hz

**Gamma Mini** N

BODY MAT AL 50 42000h L90 B10 3 MacAdam 180° 90°

05-6428-Z5-DN 05-6428-Z5-Z5 05-6428-DN-DN 05-6428-14-14

05-6428-81-81 05-6428-DN-Z5 05-6428-Z5-81 05-6428-14-DN

**LED CREE**

K	CRI	W	Real lm	▲
2700	80	2,2	137	25°

05-6428 - 14 81 Z5 DN - 14 81 Z5 DN

100-240V 50-60Hz

**Elamp** N

BODY MAT AL 4 50000h L70 B30 3 MacAdam x2 USB 355°

**LED CREE + LED SAMSUNG**

	K	W	Real lm	▲
CREE	2700	2,2	115	25°
SAMSUNG	2700	9	425	-

05-7606 - 14-14 14-DO 05-05 05-DO

220-240V 50-60Hz

Collection / Colección

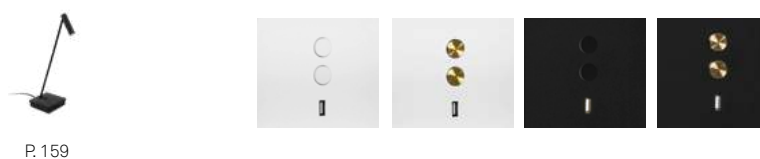

\* Available from 06/2019.  
\* Disponible a partir de 06/2019.

**Gamma USB**

BODY MAT AL 8 42000h L90 B10 3 MacAdam USB 180° 90°

**LED CREE**

K	CRI	W	Real lm	▲
2700	80	2,2	137	25°

05-6424 - 14-14 81-81

100-240V 50-60Hz

Collection / Colección



**Organic** N

BODY MAT ST 4 IP20 355° 90°

E-14 Hal - Fluo - Led / max. L 120mm Ø 80mm

W
23 max.

05-7582 - 05 - 05

Collection / Colección



Not included / No incluido





## Fino

\* Please contact our sales team for conditions and delivery times.  
\* Consultar condiciones y plazos de entrega a nuestro equipo comercial.

BODY MAT AL DIF MAT PMMA 50000h L70 B30 3 MacAdam UGR <17,8 CONTROL

LED										
K	CRI	W	lm	V						
2700	80	10,8	452	100-240	-	05-7573	-	14-14	60-60	Z5-Z5 DL-DL
				220-240	1.10V	05-7574				

8 50-60Hz

LED										
K	CRI	W	lm	V						
2700	80	21,6	905	220-240	-	05-7575	-	14-14	60-60	Z5-Z5 DL-DL
				220-240	1.10V	05-7576				

6 50-60Hz

## Radar

\* Please contact our sales team for conditions and delivery times.  
\* Consultar condiciones y plazos de entrega a nuestro equipo comercial.

BODY MAT AL/ZAM 12 50000h L80 B20 2 MacAdam 360°

LED										
K	CRI	W	Real lm							
3000	80	3,2	50	05-6488	-	14-14	60-60	Z5-Z5	DL-DL	J6-J6

8 100-240V 50-60Hz

## Lire

BODY MAT ST/ZAM 12 36000h L70 B30 2 MacAdam 355° 90°

LED CREE										
K	CRI	W	Real lm							
2700	80	2,2	125	25°	05-6068	-	14-14	81-81		

160x50 100-240V 50-60Hz

LED CREE										
K	CRI	W	Real lm							
2700	80	2,2	125	25°	05-6024	-	14-14	81-81	21-21	

160x50 100-240V 50-60Hz

Included / Includo

Double installation: recessed / surface  
Doble instalación: empotrado/superficie

## Drone

BODY MAT AL 12 50000h L70 B30 2 MacAdam 355° 0° a 90°

LED CREE										
K	CRI	W	Real lm							
2700	80	7	350	120°	05-5306	-	14-21	14-F5	14-06	CI-21 CI-F5 CI-06

12 100-240V 50-60Hz

  

LED CREE										
K	CRI	W	Real lm							
2700	80	14	613	120°	05-5307	-	14-21	14-F5	14-06	CI-21 CI-F5 CI-06

6 120-240V 50-60Hz

Tip

BODY.MAT AL 12 36 000h L70 B30 3 MacAdam 360°

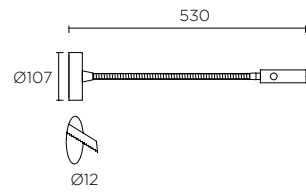

LED CREE						
K	CRI	W	Real lm	▲	■	■
3000	80	2,2	125	25°	05-5296	- 81-81 DN-DN
100-240V 50-60Hz						

Double installation: recessed / surface  
Doble instalación: empotrado/superficie

Link

BODY.MAT AL 40000h L90 B10 3 MacAdam 360°

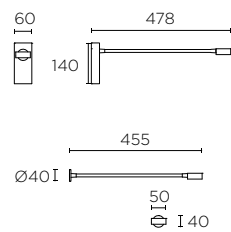
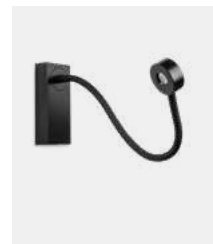

LED CREE					
K	CRI	W	Real lm	■	■
2700	80	2,1	121	05-7366	- 14-14 05-05
100-240V 50-60Hz  10					

Double installation: recessed / surface  
Doble instalación: empotrado/superficie

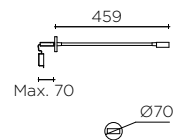
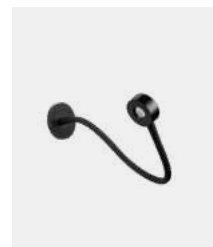

LED CREE					
K	CRI	W	Real lm	■	■
2700	80	2,1	121	05-7367	- 14-14 05-05
30   Ø44 100-240V 50-60Hz					

Contrast



BODY.MAT ST / CON / WOOD 4

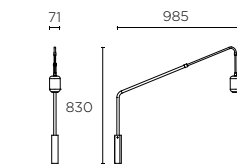
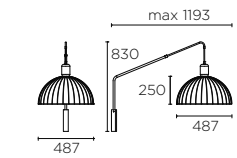
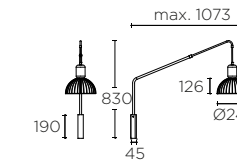

E-27 Hal - Fluo - Led						
W	■	■	■	*	■	*
60 max.	05-6415	- DC 93	- 05	F5	14	J6
100-240V 50-60Hz						

E-27 Hal - Fluo - Led						
W	■	■	■	*	■	*
60 max.	05-6414	- DC 93	- 05	F5	14	J6
100-240V 50-60Hz						

E-27 Hal - Fluo - Led						
W	■	■	■	*	■	*
60 max.	05-7365	- DC 93	- 05			
100-240V 50-60Hz						

\* Please contact our sales team for conditions and delivery times.  
\* Consultar condiciones y plazos de entrega a nuestro equipo comercial.

Collection / Colección



P.129

Not included / No incluido



71-6417 - 05 - 05

## Stylus

BODY MAT AL 30 36000h L70 B30 3 MacAdam 355° 90°

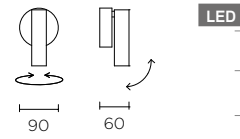

LED									
K	CRI	W	Real lm	Beam	Color	Color	Color	Color	Color
3000	80	3,4	166	40°	05-6193	-	14-14	05-05	

100-240V 50-60Hz

BODY MAT AL 50 50000h L70 B30 3 MacAdam 355° 90°

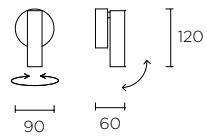

LED									
K	CRI	W	Real lm	Beam	Color	Color	Color	Color	Color
3000	82	7,5	584	40°	05-5478	-	14-14	05-05	

### Collection / Colección



P.132

## Ivy

BODY MAT ST 12 36000h L70 B30 3 MacAdam 355° 90°

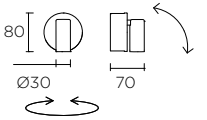

LED CREE									
K	CRI	W	Real lm	Beam	Color	Color	Color	Color	Color
3000	80	2,2	112	25°	05-2706	-	81-81	21-21	E4-E4

Ø60 100-240V 50-60Hz

## Book

BODY MAT ST 36000h L70 B30 3 MacAdam 360°

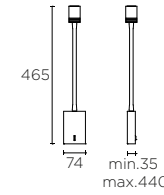

LED CREE									
K	CRI	W	Real lm	Beam	Color	Color	Color	Color	Color
3000	80	2,2	137	30°	05-5625	-	05	-	81

100-240V 50-60Hz

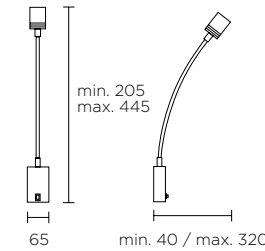

LED CREE									
K	CRI	W	Real lm	Beam	Color	Color	Color	Color	Color
3000	80	3	125	30°	05-2845	-	21	-	21

100-240V 50-60Hz

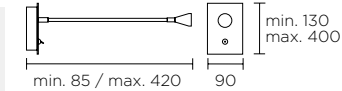

LED CREE									
K	CRI	W	Real lm	Beam	Color	Color	Color	Color	Color
3000	80	2,2	125	30°	05-2837	-	21	-	21

100-240V 50-60Hz

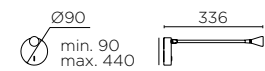

LED CREE									
K	CRI	W	Real lm	Beam	Color	Color	Color	Color	Color
3000	80	2,2	125	30°	05-2838	-	21	-	21

100-240V 50-60Hz

Double installation: recessed / surface  
Doble instalación: empotrado/superficie

# Bed

BODY MAT AL 20 36000h L70 B30 3 MacAdam 360°

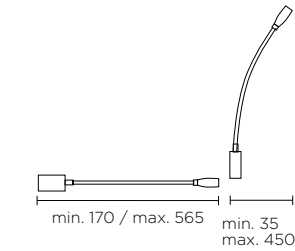
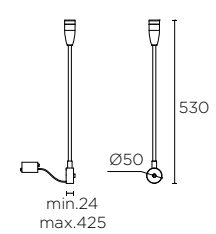

LED CREE

K	CRI	W	Real lm	▲	■	■
3000	80	2,2	127	40°	05-2830	34-34 05-05

100-240V 50-60Hz

LED CREE

K	CRI	W	Real lm	▲	■	■
3000	80	2,2	127	25°	05-2831	34-34 05-05

100-240V 50-60Hz

# Gloss

BODY MAT ST SHADE MAT COT 12



05-2755-81-21 + PAN-157-BY

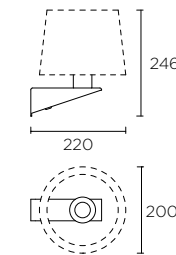

E-27 Hal - Fluo - Led

W	60 max.	05-2755	-	81	-	21	+ PAN
---	---------	---------	---	----	---	----	-------

05-2756-81-21 + PAN-219-14

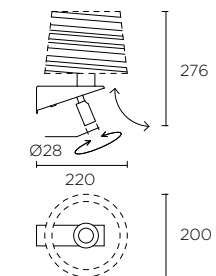

LED CREE + E27 Hal - Fluo - Led

	K	W	Real lm	▲	■	■
LED	3000	1	137	25°	05-2756	- 81 - 21 + PAN
E27		60 max.				

36000h L70 B30 3 MacAdam 355° 90° 100-240V 50-60Hz

Not included and required / No incluido y requerido

<b>PAN-175</b>	<b>PAN-177</b>	<b>PAN-157</b>	<b>PAN-194</b>	<b>PAN-219</b>	<b>PAN-178</b>	<b>PAN-179</b>	<b>PAN-176</b>
14 BY	14 BY	14 BY 05	AJ	14 05	14 BY	14 BY	14 BY
12	6	5	8	5	10	10	6
max. L 125 mm Ø 110 mm	max. L 140 mm Ø 120 mm	max. L 140 mm Ø 135 mm	max. L 160 mm Ø 155 mm	max. L 140 mm Ø 135 mm	max. L 135 mm Ø 80 mm	max. L 175 mm Ø 120 mm	max. L 160 mm Ø 120 mm

# Bali

BODY MAT ST SHADE MAT COT 8



05-3217-19-82 + PAN-157-BY

05-3218-21-82 + PAN-157-14

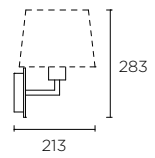

E-27 Hal - Fluo - Led	
W	
60 max.	05-3217 - 81 21 19 - 82 + PAN

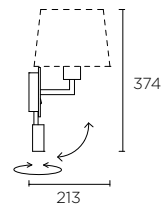

LED CREE + E27 Hal - Fluo - Led			
K	W	Real lm	▲
LED 3000	2,1	182	25°
E27	60 max.	05-3218 - 81 21 19 - 82 + PAN	

36000h L70 B30 3 MacAdam x2 355° 90°  
100-240V 50-60Hz

Not included and required / No incluido y requerido

<b>PAN-175</b>	<b>PAN-177</b>	<b>PAN-157</b>	<b>PAN-219</b>	<b>PAN-178</b>	<b>PAN-176</b>
14 BY	14 BY	14 BY 05	14 05	14 BY	14 BY
12	6	5	5	10	6
max. L 125 mm Ø 110 mm	max. L 140 mm Ø 120 mm	max. L 140 mm Ø 135 mm	max. L 140 mm Ø 135 mm	max. L 135 mm Ø 80 mm	max. L 160 mm Ø 120 mm

# Michigan

BODY MAT ST SHADE MAT COT 8 36000h L70 B30 3 MacAdam 355° 90°

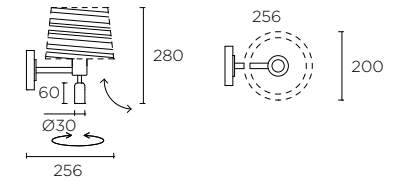

LED + E27 Hal - Fluo - Led			
K	W	Real lm	▲
LED 3000	1	107	25°
E27	60 max.	05-2758 - 14 - 82 + PAN	

100-240V 50-60Hz

05-2758-14-82+PAN-219-14

Not included and required / No incluido y requerido

<b>PAN-175</b>	<b>PAN-177</b>	<b>PAN-157</b>	<b>PAN-194</b>	<b>PAN-219</b>	<b>PAN-178</b>	<b>PAN-179</b>	<b>PAN-176</b>
14 BY	14 BY	14 BY 05	AJ	14 05	14 BY	14 BY	14 BY
12	6	5	8	5	10	10	6
max. L 125 mm Ø 110 mm	max. L 140 mm Ø 120 mm	max. L 140 mm Ø 135 mm	max. L 160 mm Ø 155 mm	max. L 140 mm Ø 135 mm	max. L 135 mm Ø 80 mm	max. L 175 mm Ø 120 mm	max. L 160 mm Ø 120 mm

Collection / Colección



P. 161 P. 164

# Bristol

BODY MAT ST SHADE MAT COT 12



05-2815-81-81+PAN-177-BY

**E-27** Hal - Fluo - Led  
**W**  
 60 max. **05-2815 - 81 - 81 + PAN**

05-2820-21-21+PAN-176-14

**LED CREE + E27** Hal - Fluo - Led  

K	W	Real lm	▲
LED 3000	2,2	182	25°
E27	60 max.		

**05-2820 - 21-21 81-81 + PAN**  
 36000h L70 B30 3 MacAdam 360°  
 100-240V 50-60Hz

Not included and required / No incluido y requerido

 <b>PAN-175</b> 14 BY 12 max.L 125 mm Ø 110 mm	 <b>PAN-177</b> 14 BY 6 max.L 140 mm Ø 120 mm	 <b>PAN-157</b> 14 BY 05 5 max.L 140 mm Ø 135 mm	 <b>PAN-219</b> 14 05 5 max.L 140 mm Ø 135 mm	 <b>PAN-178</b> 14 BY 10 max.L 135 mm Ø 80 mm	 <b>PAN-179</b> 14 BY 10 max.L 175 mm Ø 120 mm	 <b>PAN-176</b> 14 BY 6 max.L 160 mm Ø 120 mm
---	--	---	--	--	---	--

Collection / Colección



# Funk

BODY MAT ST 6 355° 90°

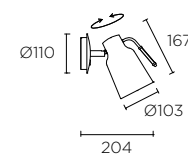

**E-27** Hal - Fluo - Led / max. L 125mm Ø 80mm

W	
40 max.	<b>05-4755 - CI - 23</b>

Collection / Colección

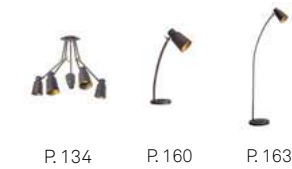

# Pipe

BODY MAT AL IP23 8

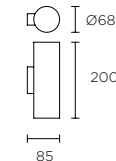

**GU10** Hal - Led

W	▲	■*	■*	■*	■*
2 x 50 max.					

**05-2759 - 14-05 05-05 Z5-Z5 DL-DL J6-J6**

\* Please contact our sales team for conditions and delivery times.  
\* Consultar condiciones y plazos de entrega a nuestro equipo comercial.

Not included / No incluido



<b>71-0073 -</b>	<b>14-14</b>	<b>05-05</b>	<b>Z5-Z5</b>	<b>DL-DL</b>	<b>J6-J6</b>

50

Collection / Colección



# Kub

\* Please contact our sales team for conditions and delivery times.  
\* Consultar condiciones y plazos de entrega a nuestro equipo comercial.

BODY MAT AL 6 60000h L90 B10 2 MacAdam

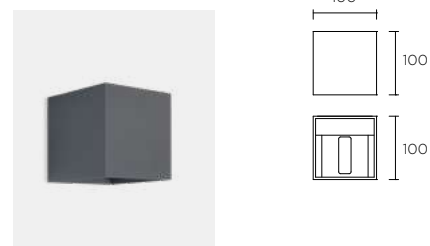

LED CREE		K	CRI	W	Real lm						
3000	80	4,3	271	05-3220	- 14-14	60-60	25-25	34-34	Z5-Z5	DL-DL	J6-J6

100-240V 50-60Hz

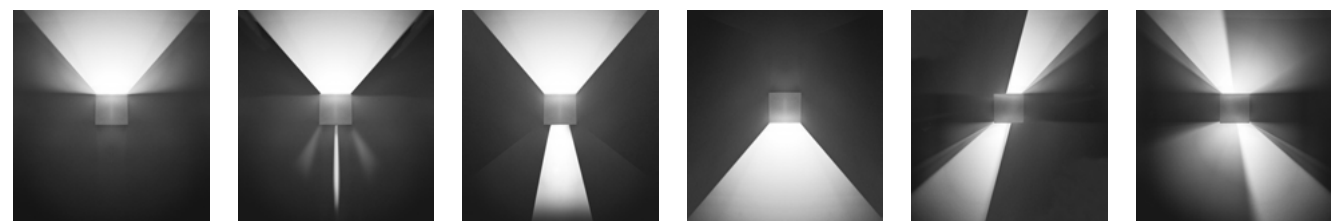

# Eclipse

BODY MAT CON 9 50000h L70 B30 3 MacAdam

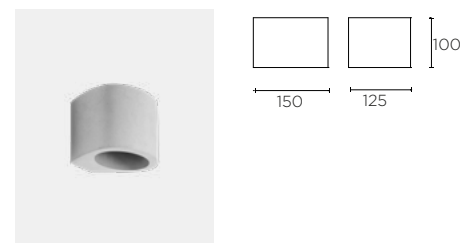

LED CREE		K	CRI	W	Real lm		
2700	80	4,6	226	05-6006	- DC - DC		

100-240V 50-60Hz

## Collection / Colección

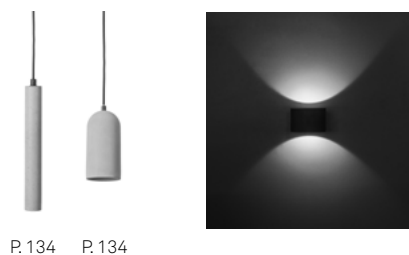

P.134 P.134

# Ges

BODY MAT PLASTER



E14	Hal - Fluo - Led
W	40 max. 05-1793 - 14 - 14

12

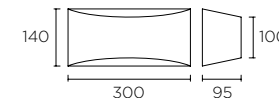

E14	Hal - Fluo - Led
W	40 max. 05-1796 - 14 - 14

8

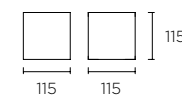
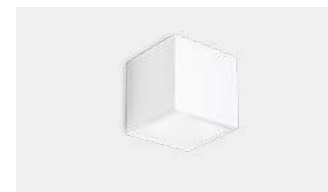

G9	W
40 max.	05-1794 - 14 - 14

18

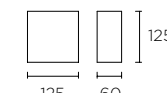

LED CREE		K	CRI	W	Real lm		
3000	80	4,4	330	05-1798	- 14 - 14		

36000h L70 B30 3 MacAdam 10 100-240V 50-60Hz

# Ges

BODY MAT ST / PLASTER DIF. MAT ACR IP20 50000h L80 B20 3 MacAdam

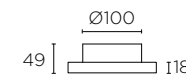

LED		K	CRI	W	Real lm		
3000	80	3	386	05-7641	- 14 - 14		

16 100-240V 50-60Hz

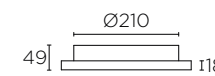

ED		K	CRI	W	Real lm		
3000	80	7,2	665	05-7642	- 14 - 14		

8 100-240V 50-60Hz

# Vintage

BODY MAT ST / AL DIF MAT GLA 50000h L70 B30 2 MacAdam

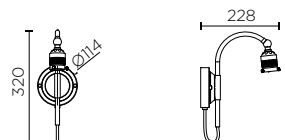
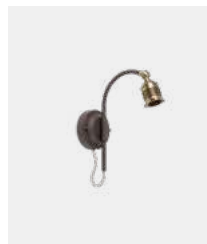

LED CREE		K	CRI	W	Real lm		
3000	80	8,3	765	71-4819	-	CI	CI
100-240V 50-60Hz		8					

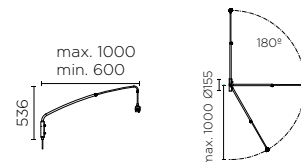

LED CREE		K	CRI	W	Real lm		
3000	80	8,3	765	71-5490	-	CI	CI
100-240V 50-60Hz		4					
		180°					

## Accessories / Accesorios

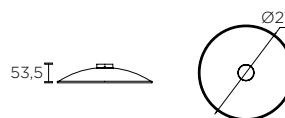

71-4821 - CU-CU		Color options: [Red] [White] [Black] [White*] [Black*] [Grey*] [Gold*] [Brown*]						
-	-	14-14	60-60	Z5-Z5	DL-DL	J6-J6	8	

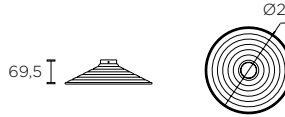

71-4824 - -		Color options: [White] [Black] [Grey] [Gold] [Brown]						
20-20	CI-CI	14-14	60-60	Z5-Z5	DL-DL	J6-J6	8	

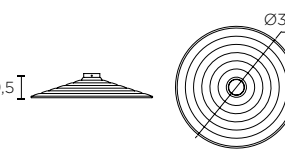

71-4940 - -		Color options: [White] [Black] [Grey] [Gold] [Brown]						
CI-CI	14-14	60-60	Z5-Z5	DL-DL	J6-J6	8		



71-4825 - -		Color options: [White] [Black] [Grey] [Gold] [Brown]						
CI-CI	14-14	60-60	Z5-Z5	DL-DL	J6-J6	8		

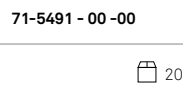

71-4817 - F1-F1		Color options: [White] [Black] [Grey] [Gold] [Brown]						
139	Ø80	8						

71-4818 - F1-F1		Color options: [White] [Black] [Grey] [Gold] [Brown]						
139	Ø80	8						

71-5491 - 00-00		Color options: [White] [Black] [Grey] [Gold] [Brown]						
20								

## Collection / Colección

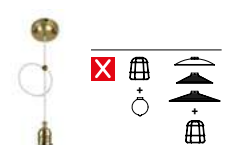

P.136

# Duna

BODY MAT AL DIF MAT PMMA 50000h L70 B30 3 MacAdam COMPATIBLE CASAMBI

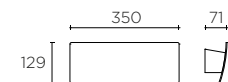

LED SAMSUNG		K	CRI	W	Real lm	V	Color options: [White] [Grey] [Black*] [Dark Grey*] [Gold*] [Brown*]						
3000	80	30	2339	100-240 220-240	MAINS LC	-	05-5964 05-5965	14 - M1	34 - M1	60 - M1	Z5 - M1	DL - M1	J6 - M1
100-240V 50-60Hz		8											

50-60Hz

# Attic

BODY MAT AL 16

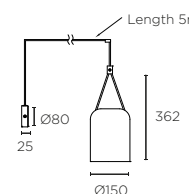

E-27 Hal - Fluo - Led / max. L 120mm Ø 100mm		Color options: [White] [Black] [Gold*]			
23 max.	05-7388	05-14	05-05	05-DL	

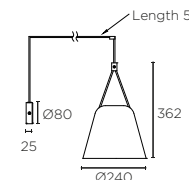

E-27 Hal - Fluo - Led / max. L 120mm Ø 100mm		Color options: [White] [Black] [Gold*]			
23 max.	05-7389	05-14	05-05	05-DL	

\* Please contact our sales team for conditions and delivery times.  
\* Consultar condiciones y plazos de entrega a nuestro equipo comercial.

## Collection / Colección



P.127



Room N

\* Please contact our sales team for conditions and delivery times.  
\* Consultar condiciones y plazos de entrega a nuestro equipo comercial.

BODY MAT AL / ST DIF MAT PMMA 50000h L70 B30 3 MacAdam

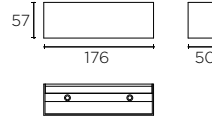

LED SAMSUNG

K	CRI	W	Real lm	Color 1	Color 2	Color 3	Color 4	Color 5
3000	80	8,1	583	05-7370	14-14	81-81	60-60	Z5-Z5 DL-DL

8 100-240V 50-60Hz

<p>0 58</p> <p>14 43</p> <p>5u. 40</p>	<p>71-7370 - 14-14 81-81 60-60 Z5-Z5 DL-DL</p>	<p>5 56</p> <p>14 42</p> <p>5u. 40</p>	<p>71-7375 - 14-14 81-81 60-60 Z5-Z5 DL-DL</p>
<p>1 58</p> <p>14 28</p> <p>5u. 40</p>	<p>71-7371 - 14-14 81-81 60-60 Z5-Z5 DL-DL</p>	<p>6 58</p> <p>14 43</p> <p>5u. 40</p>	<p>71-7376 - 14-14 81-81 60-60 Z5-Z5 DL-DL</p>
<p>2 58</p> <p>14 41</p> <p>5u. 40</p>	<p>71-7372 - 14-14 81-81 60-60 Z5-Z5 DL-DL</p>	<p>7 56</p> <p>14 42</p> <p>5u. 40</p>	<p>71-7377 - 14-14 81-81 60-60 Z5-Z5 DL-DL</p>
<p>3 58</p> <p>14 42</p> <p>5u. 40</p>	<p>71-7373 - 14-14 81-81 60-60 Z5-Z5 DL-DL</p>	<p>8 58</p> <p>14 42</p> <p>5u. 40</p>	<p>71-7378 - 14-14 81-81 60-60 Z5-Z5 DL-DL</p>
<p>4 56</p> <p>14 43</p> <p>5u. 40</p>	<p>71-7374 - 14-14 81-81 60-60 Z5-Z5 DL-DL</p>	<p>9 58</p> <p>14 43</p> <p>5u. 40</p>	<p>71-7379 - 14-14 81-81 60-60 Z5-Z5 DL-DL</p>



Gamma

BODY MAT ST/AL DIF MAT PC 42000h L90 B10 3 MacAdam 355° 90°

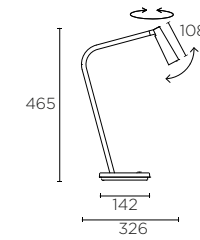

LED CREE

K	CRI	W	Real lm	Beam	Color 1	Color 2	Color 3	Color 4
2700	80	2,2	121	60°	10-6420	14-14	81-81	DN-DN Z5-Z5

100-240V 50-60Hz

Collection / Colección



Elamp N



BODY MAT AL 50000h L70 B30 2 MacAdam USB

\* Available from 06/2019.  
\* Disponible a partir de 06/2019.

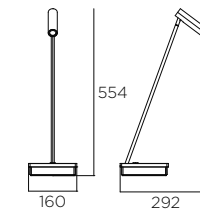

LED CREE

K	W	Real lm	MacAdam	Beam	Color 1	Color 2	Color 3	Color 4
2700	2,2	141	3	60°	10-7606	14-14	14-DO	05-05 05-DO

100-240V 50-60Hz

LED CREE

K	W	Real lm	MacAdam	Beam	Color 1	Color 2	Color 3	Color 4
2700	2,2	141	3	60°	10-7607	14-14	14-DO	05-05 05-DO

100-240V 50-60Hz

Collection / Colección



P.141

## Organic N

BODY MAT ST R □ IP20 4 ⏻ ⏻ 355° ↻ 90°

\* Available from 06/2019.  
\* Disponible a partir de 06/2019.

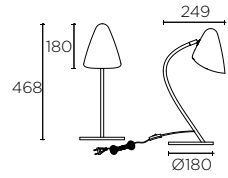

**E-27** Hal - Fluo - Led / max. L 120mm Ø 80mm

W	
23 max.	<b>10-7582 - 05 - 05</b>

### Collection / Colección



P.141



P.163

## Funk

BODY MAT ST R □ 4 ⏻ ⏻ 355° ↻ 90°

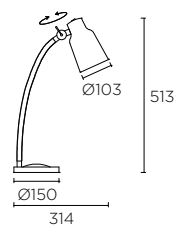
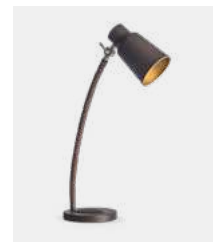

**E-27** Hal - Fluo - Led / max. L 125mm Ø 80mm

W	
23 max.	<b>10-4755 - CI - 23</b>

### Collection / Colección



P.153



P.134



P.163



## Elva

BODY MAT AL □ 6 50000h **L70 B30** 3 MacAdam ⏻ ⏻

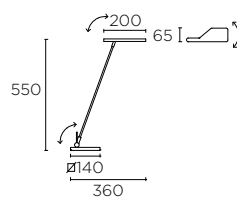

**LED** CITIZEN

K	CRI	W	Real lm		
3000	80	4,7	301	<b>10-1523 - 21 - 21</b>	

100-240V 50-60Hz

## Michigan

BODY MAT ST SHADE MAT COT R □ 8 ⏻ ⏻

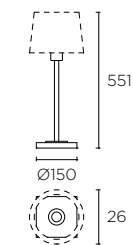

**E-27** Hal - Fluo - Led

W	
60 max.	<b>10-2757 - 14 - 82 + PAN</b>

### Not included and required / No incluido y requerido

<b>PAN-177</b>	<b>PAN-157</b>	<b>PAN-194</b>	<b>PAN-161</b>	<b>PAN-219</b>	<b>PAN-179</b>	<b>PAN-180</b>	<b>PAN-176</b>
14 BY	14 BY 05	AJ	14 BY	14 05	14 BY	14 BY	14 BY
<span style="border: 1px solid black; padding: 2px;">6</span>	<span style="border: 1px solid black; padding: 2px;">5</span>	<span style="border: 1px solid black; padding: 2px;">8</span>	<span style="border: 1px solid black; padding: 2px;">5</span>	<span style="border: 1px solid black; padding: 2px;">5</span>	<span style="border: 1px solid black; padding: 2px;">10</span>	<span style="border: 1px solid black; padding: 2px;">5</span>	<span style="border: 1px solid black; padding: 2px;">6</span>
max. L 140 mm Ø 120 mm	max. L 140 mm Ø 135 mm	max. L 160 mm Ø 155 mm	max. L 190 mm Ø 185 mm	max. L 140 mm Ø 135 mm	max. L 175 mm Ø 120 mm	max. L 205 mm Ø 150 mm	max. L 160 mm Ø 120 mm
•	•	•	•	•	•	•	•

### Collection / Colección



P.151



P.164

# Bristol

BODY MAT ST SHADE MAT COT 8

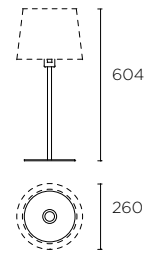

E-27 Hal - Fluo - Led  
**W**  
 60 max. **10-4759 - 81 - 82 + PAN - 161 - 05**

Not included and required / No incluido y requerido

<b>PAN-177</b>	<b>PAN-157</b>	<b>PAN-194</b>	<b>PAN-161</b>	<b>PAN-219</b>	<b>PAN-179</b>	<b>PAN-180</b>	<b>PAN-176</b>
14 BY	14 BY 05	AJ	14 BY 05	14 05	14 BY	14 BY	14 BY
6	5	8	5	5	10	5	6
max. L 140 mm Ø 120 mm	max. L 140 mm Ø 135 mm	max. L 160 mm Ø 155 mm	max. L 190 mm Ø 185 mm	max. L 140 mm Ø 135 mm	max. L 175 mm Ø 120 mm	max. L 205 mm Ø 150 mm	max. L 160 mm Ø 120 mm

Collection / Colección



# Funk

BODY MAT ST 2 355° 90°

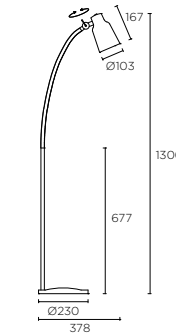

E-27 Hal - Fluo - Led / max. L 125mm Ø 80mm  
**W**  
 60 max. **25-4755 - CI - 23**

Collection / Colección



# Organic N

BODY MAT ST IP20 1 355° 90°

\* Disponible a partir de 06/2019.  
 \* Available from 06/2019.

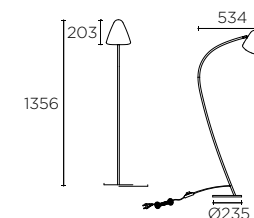
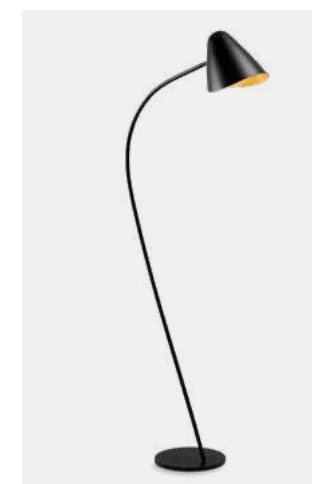

E-27 Hal - Fluo - Led / max. L 120mm Ø 80mm  
**W**  
 23 max. **25-7582 - 05 - 05**

Collection / Colección



## Vintage

16-25 Z5-10



BODY MAT ST 2 180° GLOBE 20W

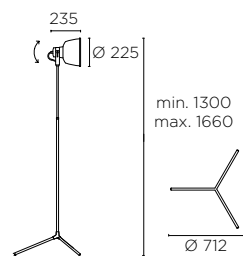

<b>E27</b> Hal - Fluo - Led / max. L 175mm Ø 85mm			
<b>W</b>			
60 max.	25-0240	- 21 -	16 Z5

Collection / Colección



P. 138

## Michigan

BODY MAT ST 4

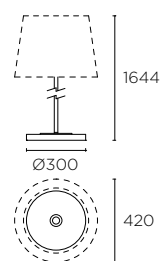

<b>E-27</b> Hal - Fluo - Led			
<b>W</b>			
100 max.	25-2757	- 14 -	82 + PAN - 159 - 14

Not included and required / No incluido y requerido

<b>PAN-159</b>	<b>PAN-181</b>	<b>PAN-182</b>	<b>PAN-183</b>
14 BY 05	14 BY	14 BY	14 BY
5	5	4	4
max. L 245 mm Ø 290 mm	max. L 280 mm Ø 220 mm	max. L 190 mm Ø 155 mm	max. L 220 mm Ø 170 mm

Collection / Colección



P. 151

P. 161

## Bristol

BODY MAT ST 4

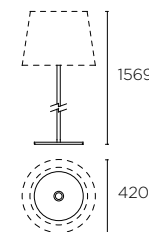

**E-27** Hal - Fluo - Led

<b>W</b>			
100 max.	25-4759	- 81 -	82 + PAN - 159 - 14

Not included and required / No incluido y requerido

<b>PAN-184</b>	<b>PAN-159</b>	<b>PAN-181</b>	<b>PAN-182</b>	<b>PAN-183</b>
14 BY	14 BY 05	14 BY	14 BY	14 BY
5	5	5	4	4
max. L 190 mm Ø 240 mm	max. L 245 mm Ø 290 mm	max. L 280 mm Ø 220 mm	max. L 190 mm Ø 155 mm	max. L 220 mm Ø 170 mm

Collection / Colección



P. 152

P. 152

P. 162

## Toilet Slim

BODY MAT AL 4 50000h L70 B30 3 MacAdam

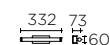

<b>LED SAMSUNG</b>			
<b>K</b>	<b>CRI</b>	<b>W</b>	<b>Real lm</b>
3000	90	10,8	880
<b>05-6395 - 21 - M1</b>			

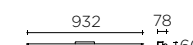

<b>LED SAMSUNG</b>			
<b>K</b>	<b>CRI</b>	<b>W</b>	<b>Real lm</b>
3000	90	28,3	2431
<b>05-6397 - 21 - M1</b>			

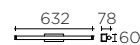

<b>LED SAMSUNG</b>			
<b>K</b>	<b>CRI</b>	<b>W</b>	<b>Real lm</b>
3000	90	22	1777
<b>05-6396 - 21 - M1</b>			

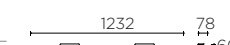

<b>LED SAMSUNG</b>			
<b>K</b>	<b>CRI</b>	<b>W</b>	<b>Real lm</b>
3000	90	37,6	3472
<b>05-6398 - 21 - M1</b>			

Vetro N

BODY MAT ST DIF MAT GLA IP44 IK05 50000h L70 B30 3 MacAdam 2

\* Available from 06/2019.  
\* Disponible a partir de 06/2019.

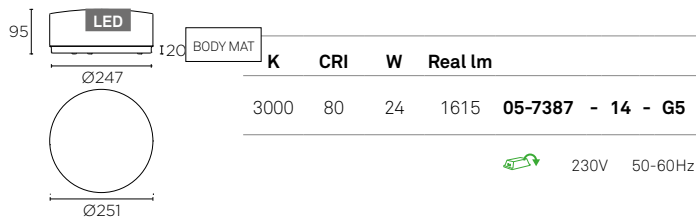

K	CRI	W	Real lm
3000	80	24	1615

230V 50-60Hz

Atom track 52



BODY MAT AL DIF MAT PC IP20 90° 320°



LED AC

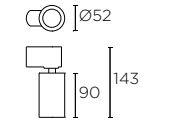

LED VOSSLÖH			
K	CRI	W	Real lm
2700	90	7,5	331 24° 319 33° 259 43°
3000	90	7,5	331 24° 319 33° 259 43°

40000h L70 B50 3 MacAdam

MS MAINS L,C 220-240V 50-60Hz  
ML MAINS L,C 110V-130V 50-60Hz

Not included / No incluido

ACT-9105 - 14 - 00 60

Surface Superficie

71-5953 - 14 - 00 60

Recessed Empotrado



LED DRIVER

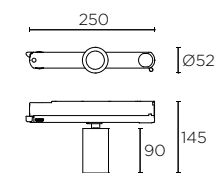

LED CREE <span style="color: orange;">N</span>			
K	CRI	W	Real lm
2700	90	12,1	853 24° 928 33° 778 43°
3000	90	12,1	853 24° 928 33° 778 43°

60000h L90 B10 2 MacAdam

OS ON/OFF 220-240V 50-60Hz 1,2% Ripple  
ES DALI 220-240V 50-60Hz 1,5% Ripple

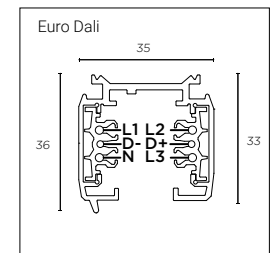

P. 177

Not included / No incluido

- Visual Comfort Confort visual **71-6276 - 60 - 00**
- Visor Visera **71-6277 - 60 - 00**
- Front ring Aro frontal **71-6436 - 14 - 00 23**

- 5 x Elliptical Diffuser 5 x Difusor elíptico **71-6274 - 00 - 00**
- 5 x Honeycomb 5 x Panel de abeja **71-6273 - 60 - 00**
- 5 x Softening Lens 5 x Difuminador de halo **71-6275 - 00 - 00**

Photometric data / Fotometría



LED CRI90 3000K 12,2W 15°

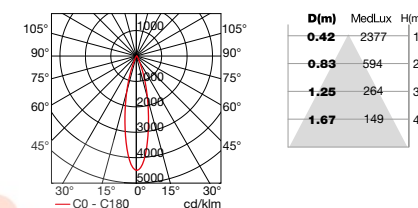

LED CRI90 3000K 12,2W 30°

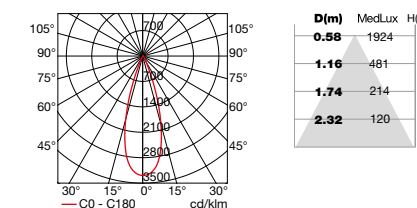

LED CRI90 3000K 12,2W 50°

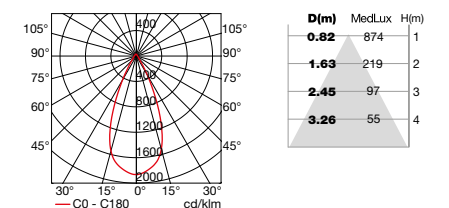

# Atom track 75



BODY MAT AL DIF MAT PC IP20 90° 320°



LED AC

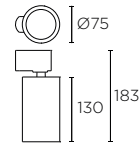

LED VOSSLOH					
K	CRI	W	Real lm	Beam	Code
2700	90	14,3	1005	22°	<b>35-6279</b>
			861	31°	<b>35-6280 - 14 - 60 - MS</b>
			668	39°	<b>35-6281</b>
3000	90	14,3	1005	22°	<b>35-6282</b>
			861	31°	<b>35-6283 - 14 - 60 - MS ML</b>
			668	39°	<b>35-6284</b>

40000h L70 B50 3 MacAdam  
**MS** MAINS L.C 220-240V 50-60Hz  
**ML** MAINS L.C 110V-130V 50-60Hz

### Not included / No incluido



**ACT-9105 - 14 - 00 - 60**  
 Surface Superficie  
**71-5953 - 14 - 00 - 60**

Recessed Empotrado



LED DRIVER

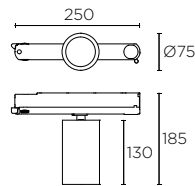

LED CREE N					
K	CRI	W	Real lm	Beam	Code
2700	90	24	2404	22°	<b>35-7305</b>
			1991	31°	<b>35-7306 - 14 - 60 - OS ES</b>
			1567	39°	<b>35-7307</b>
3000	90	24	2404	22°	<b>35-7308</b>
			1991	31°	<b>35-7309 - 14 - 60 - OS ES</b>
			1567	39°	<b>35-7310</b>

60000h L90 B10 2 MacAdam  
**OS** ON/OFF 220-240V 50-60Hz 1,5% Ripple  
**ES** DALI 220-240V 50-60Hz 2,9% Ripple

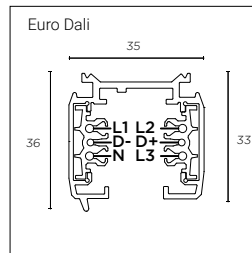

P. 177

### Not included / No incluido

- 50** Visual Comfort Confort visual **71-6282 - 60 - 00**
- Visor Visera **71-6283 - 60 - 00**
- Front ring Aro frontal **71-6437 - 14 - 00 - 23**

- 100** 5 x Elliptical Diffuser 5 x Difusor elíptico **71-6280 - 00 - 00**
- 5 x Honeycomb 5 x Panel de abeja **71-6279 - 60 - 00**
- 5 x Softening Lens 5 x Difuminador de halo **71-6281 - 00 - 00**

### Photometric data / Fotometría

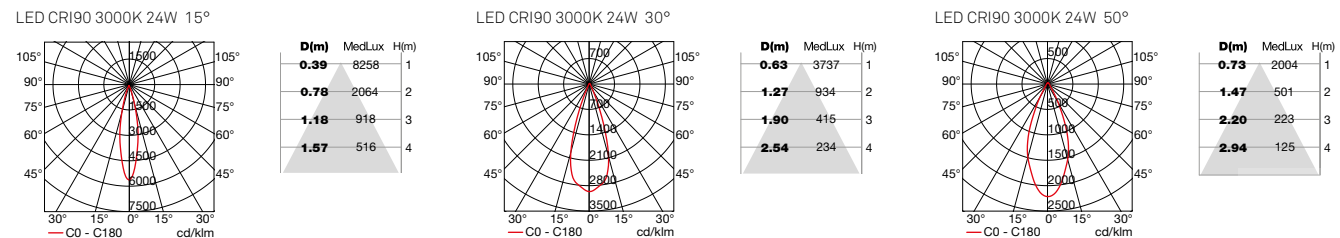

# Atom track 97

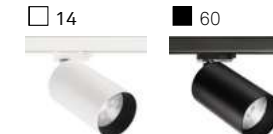

BODY MAT AL DIF MAT PC IP20 90° 320°



LED AC

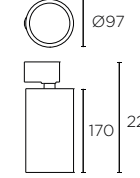

LED VOSSLOH					
K	CRI	W	Real lm	Beam	Code
2700	90	31	1850	24°	<b>35-6285</b>
			1586	36°	<b>35-6286 - 14 - 60 - MS</b>
			1252	43°	<b>35-6287</b>
3000	90	31	1850	24°	<b>35-6288</b>
			1586	36°	<b>35-6289 - 14 - 60 - MS ML</b>
			1252	43°	<b>35-6290</b>

40000h L70 B50 3 MacAdam  
**MS** MAINS L.C 220-240V 50-60Hz  
**ML** MAINS L.C 110V-130V 50-60Hz

### Not included / No incluido

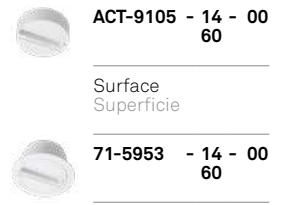

**ACT-9105 - 14 - 00 - 60**  
 Surface Superficie  
**71-5953 - 14 - 00 - 60**

Recessed Empotrado



LED DRIVER

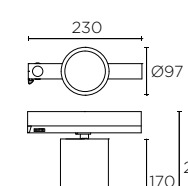

LED CREE N					
K	CRI	W	Real lm	Beam	Code
2700	90	37,3	3529	24°	<b>35-7323</b>
			3056	36°	<b>35-7324 - 14 - 60 - OS</b>
			2369	43°	<b>35-7325</b>
3000	90	37,3	3529	24°	<b>35-7326</b>
			3056	36°	<b>35-7327 - 14 - 60 - OS</b>
			2369	43°	<b>35-7328</b>

60000h L90 B10 2 MacAdam  
**OS** ON/OFF 220-240V 50-60Hz 0,8% Ripple

### LED TRIDONIC

K	CRI	W	Real lm	Beam	Code
FRESH 3000	98	24,1	2468	24°	<b>35-7323</b>
			2137	36°	<b>35-7324 - 14 - 60 - OF</b>
			1656	43°	<b>35-7325</b>

50000h L80 B50 2 MacAdam  
**O** ON/OFF 220-240V 50-60Hz 5% Ripple

### Not included / No incluido

- 50** Visual Comfort Confort visual **71-6288 - 60 - 00**
- Visor Visera **71-6289 - 60 - 00**
- Front ring Aro frontal **71-6438 - 14 - 00 - 23**

- 100** 5 x Elliptical Diffuser 5 x Difusor elíptico **71-6286 - 00 - 00**
- 5 x Honeycomb 5 x Panel de abeja **71-6285 - 60 - 00**
- 5 x Softening Lens 5 x Difuminador de halo **71-6287 - 00 - 00**
- Anti-glare flap Aletas antideslumbrantes **12 71-6290 - 60 - 00**

Photometric data / Fotometría

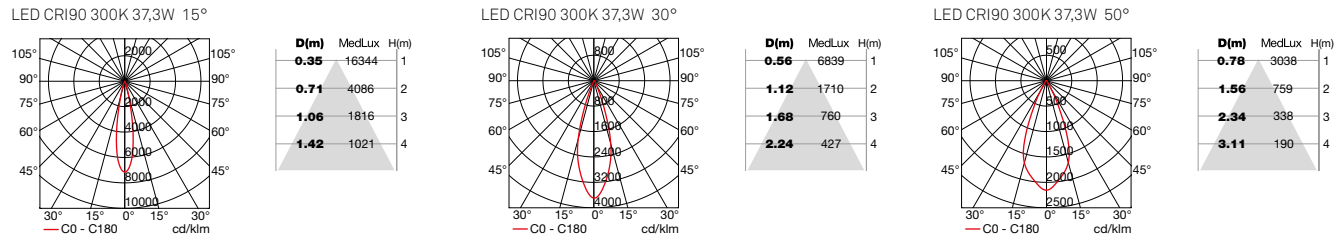

Not included / No incluido

- 50  
**Visual Comfort**  
 Confort visual **71-6276 - 60 - 00**
- 50  
**Visor**  
 Visera **71-6277 - 60 - 00**
- 50  
**Front ring**  
 Aro frontal **71-6436 - 14 - 00**  
**23**
- 100  
**5 x Elliptical Diffuser**  
 5 x Difusor elíptico **71-6274 - 00 - 00**
- 100  
**5 x Honeycomb**  
 5 x Panel de abeja **71-6273 - 60 - 00**
- 100  
**5 x Softening Lens**  
 5 x Difuminador de halo **71-6275 - 00 - 00**

Atom Hide N

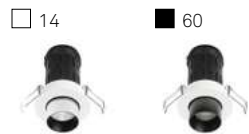

BODY MAT AL / PC IP20 60000h L90 B10 2 MacAdam 90° 320° CONTROL

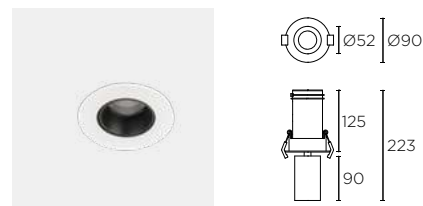

LED CREE							1 x 1	
K	CRI	W	Real lm	mA	Beam	Code	ON-OFF	71-6652
2700	90	12,1	853	350 max.	24°	<b>90-7273</b>	PHASE CUT	71-5272
			928	350 max.	33°	<b>90-7274 - 14 - 00</b>	0/1-10V	71-7710
			778	350 max.	43°	<b>90-7275</b>	0/1-10V/ PUSH/DALI	71-6192
3000	90	12,1	853	350 max.	24°	<b>90-7276</b>	P. 227	
			928	350 max.	33°	<b>90-7277 - 14 - 00</b>		
			778	350 max.	43°	<b>90-7278</b>		

Ø80 0-20mm 220-240V 50-60Hz

Photometric data / Fotometría

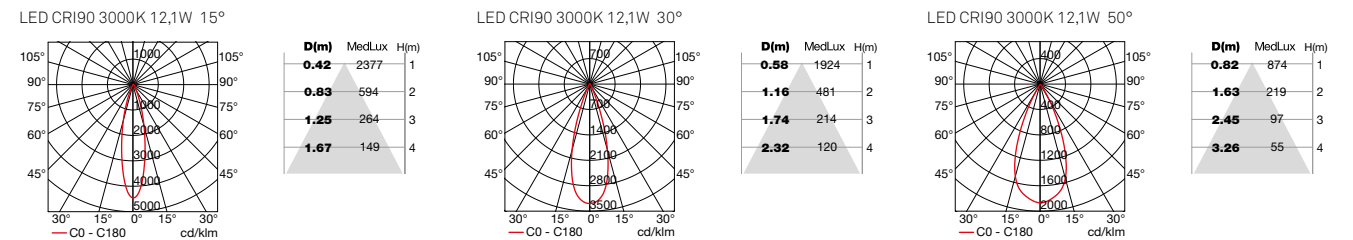

Atom Surface



BODY MAT AL DIF. MAT PC IP20 40000h L70 B50 3 MacAdam 90° 320° CONTROL



LED VOSSLOH							MS ML	
K	CRI	W	Real lm	Beam	Code	MS	ML	MAINS L.C
2700	90	7,5	331	24°	<b>15-6482</b>			220-240V
			319	33°	<b>15VVV-6483</b>	<b>- 14 - 60 - MS</b>	50-60Hz	
			259	43°	<b>15-6484</b>			
3000	90	7,5	331	24°	<b>15-6485</b>			110V
			319	33°	<b>15-6486</b>	<b>- 14 - 60 - MS ML</b>	50-60Hz	
			259	43°	<b>15-6487</b>			

## Tracks

### TRIMLESS SIN MARCO



### TRIM CON MARCO



### SUSPENDED SUSPENDIDOS



### TOP VIEW

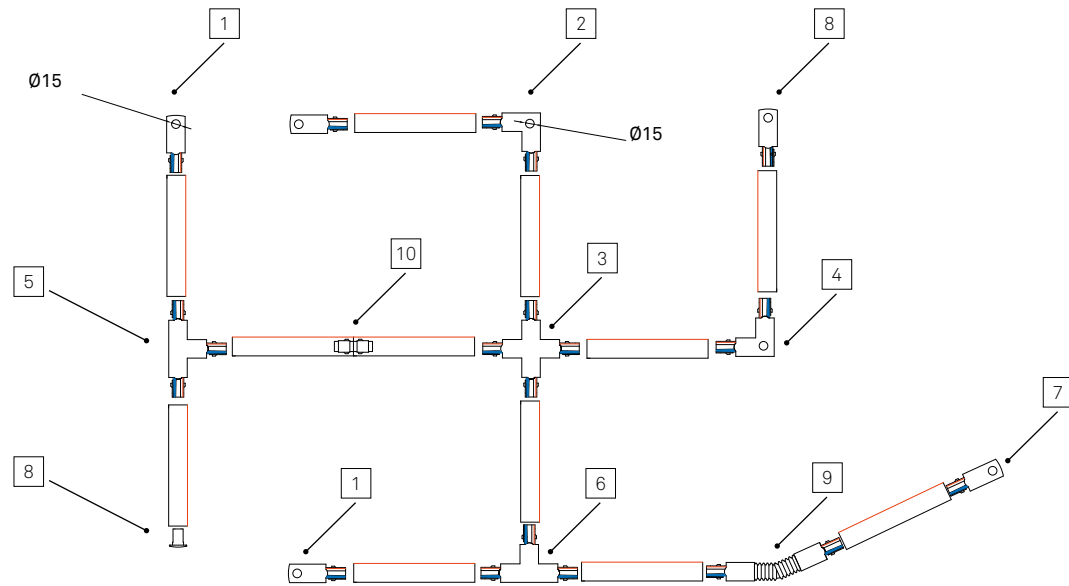

### TRIMLESS SIN MARCO

- 1 71-5214
- 2 71-5219
- 3 71-5231
- 4 71-5220
- 5 71-5227
- 6 71-5228
- 7 71-5215

### TRIM CON MARCO

- 1 71-5216
- 2 71-5221
- 3 71-5232
- 4 71-5222
- 5 71-5229
- 6 71-5230
- 7 71-5217

### TRIMLESS & TRIM SIN MARCO & CON MARCO

- 8 71-5218
- 9 71-5223
- 10 71-5224

## Tracks

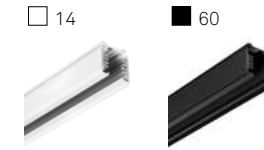

BODY MAT AL ⚡ IP20

### TRIMLESS SIN MARCO

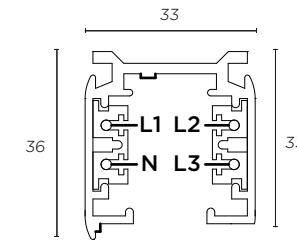

mm			
2000	71-5210	- 14	- 00
3000	71-5211	- 60	- 00

8

### TRIM CON MARCO

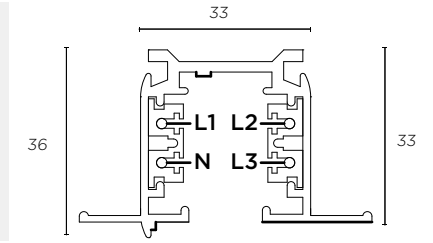

mm			
2000	71-5213	- 14	- 00
		- 60	- 00

6



## Tracks

Connection accessories /  
Accesorios de conexión

□ 14

■ 60



### TRIMLESS / SIN MARCO

Left connector / Conector izquierdo

		Mains connector (left)	Acometida izquierda	71-5214 - 14 60 - 00
		Left "L" connector	Conector "L" izquierdo	71-5219 - 14 60 - 00
		"T" connector left	Conector "T" izquierdo	71-5227 - 14 60 - 00

Right connector / Conector derecho

		Mains connector (right)	Acometida derecha	71-5215 - 14 60 - 00
		Right "L" connector	Conector "L" derecho	71-5220 - 14 60 - 00
		"T" connector right	Conector "T" derecho	71-5228 - 14 60 - 00

Connector / Conector

		"X" connector	Conector "X"	71-5231 - 14 60 - 00
--	--	---------------	--------------	-------------------------

### TRIM / CON MARCO

Left connector / Conector izquierdo

		Mains connector (left)	Acometida izquierda	71-5216 - 14 60 - 00
		Left "L" connector	Conector "L" izquierdo	71-5221 - 14 60 - 00
		"T" connector left	Conector "T" izquierdo	71-5229 - 14 60 - 00

Right connector / Conector derecho

		Mains connector (right)	Acometida derecha	71-5217 - 14 60 - 00
		Right "L" connector	Conector "L" derecho	71-5222 - 14 60 - 00
		"T" connector right	Conector "T" derecho	71-5230 - 14 60 - 00

Connector / Conector

		"X" connector	Conector "X"	71-5232 - 14 60 - 00
--	--	---------------	--------------	-------------------------

## Tracks

Connection accessories /  
Accesorios de conexión

□ 14

■ 60



### TRIMLESS & TRIM / SIN MARCO & CON MARCO

		End cap	Tapa final	71-5218 - 14 60 - 00
		Flexible Connector	Conector flexible	71-5223 - 14 60 - 00
		Straight connector	Conector continuidad	71-5224 - 14 60 - 00
		Track connector	Conector de carril	71-2232 - 14 - 14 60 - 60

Installation accessories / Elementos de fijación y accesorios

### TRIMLESS & TRIM / SIN MARCO & CON MARCO

	For direct mounting on false ceilings. 4 units/ref. Recommended for suspended installation.	Para piezas de fijación directa a falsos techos. 4 unidades/ref. Recomendado para instalación suspendida.	71-5225 - 14 60 - 00	Total mts installation / 2 = total units 71-5225 (Total units 71-5225 = total mts installation ÷ 2)
	Suspension with mains supply	Suspensión con toma de corriente	71-7520 - 14 N3 - 60	
	Steel cable + clip for suspended mounting 2 units. (1.300mm)	Sirga de acero + clip para montaje suspendido 2 unidades.	71-7656 - 14 60 - 00	Total mts installation / 2 = total units 71-7656 Total mts installation / 2 = total units 71-7656)

### TRIM NOT INCLUDED / REQUIRED / CON MARCO NO INCLUIDO / REQUERIDO

	Recessed kit. 2 units/ref	Kit para empotrar. 2 unidades/ref	ACT-9165 - 48 - 00
--	------------------------------	--------------------------------------	--------------------

1m = 1 kit  
2m = 2 kits

# Tracks Euro

## TRIMLESS SIN MARCO



## SUSPENDED SUSPENDIDOS



## TOP VIEW

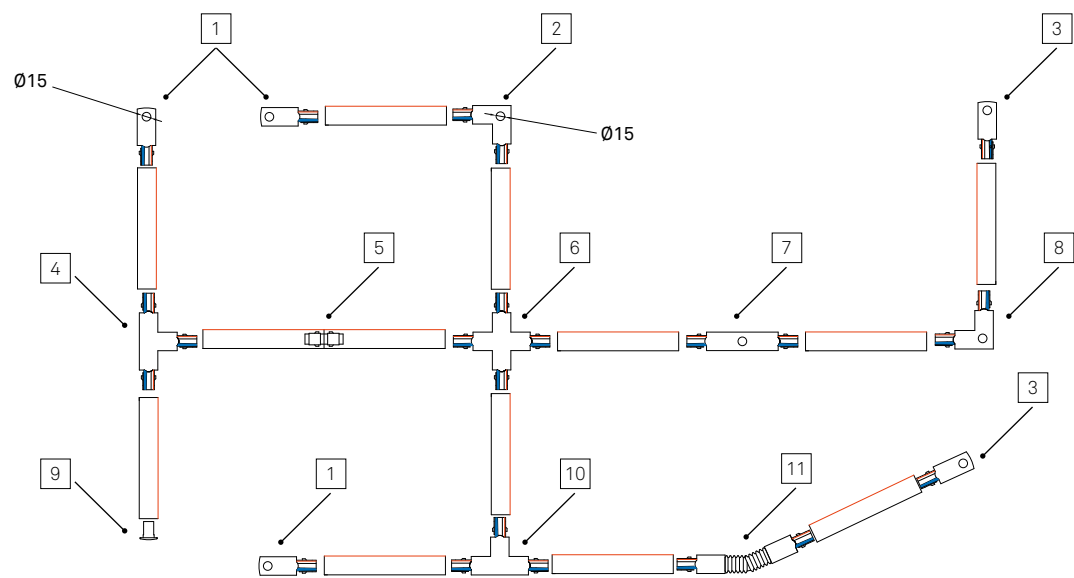

## TRIMLESS SIN MARCO

- |   |         |    |         |    |         |
|---|---------|----|---------|----|---------|
| 1 | 71-7538 | 6  | 71-7546 | 11 | 71-7547 |
| 2 | 71-7542 | 7  | 71-7541 |    |         |
| 3 | 71-7539 | 8  | 71-7543 |    |         |
| 4 | 71-7544 | 9  | 71-7537 |    |         |
| 5 | 71-7540 | 10 | 71-7545 |    |         |

# Track Euro Dali

□ 14

■ 60

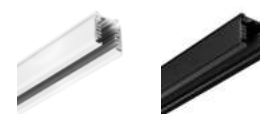

BODY MAT AL Ⓢ

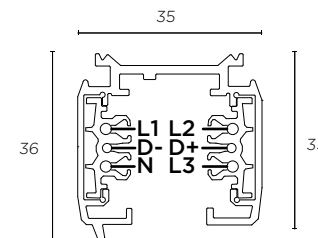

Euro Dali

mm	Ⓢ	▲	
1000	12	DALI	71-7534
2000	6	DALI	71-7535 - 14 - 00
3000	6	DALI	71-7536

100-240V 50-60Hz

## Connection accessories / Accesorios de conexión

		Mains connector (right)	Acometida derecha	DALI	71-7539	- 14 - 00
		Mains connector (left)	Acometida izquierda	DALI	71-7538	- 14 - 00
		End cap	Tapa final	DALI	71-7537	- 14 - 00
		Track / euro dali / mini union "I" mini	Carril / euro dali / union "I" mini	DALI	71-7540	- 14 - 00
		Track / euro dali / union "I"	Carril / euro dali / union "I"	DALI	71-7541	- 14 - 00
		Left "L" connector	Conector "L" izquierdo	DALI	71-7542	- 14 - 00
		Right "L" connector	Conector "L" derecho	DALI	71-7543	- 14 - 00
		"T" connector left	Conector "T" izquierdo	DALI	71-7544	- 14 - 00
		"T" connector right	Conector "T" derecho	DALI	71-7545	- 14 - 00
		"X" connector	Conector "X"	DALI	71-7546	- 14 - 00
		Flexible Connector	Conector flexible	DALI	71-7547	- 14 - 00
		Para piezas de fijación directa a falsos techos. 4 unidades/ref. Recomendado para instalación suspendida.		-	71-5225	- 14 - 00
		Suspensión con toma de corriente		DALI	71-7521	- 14 - 00
		Sirga de acero + clip para montaje suspendido 2 unidades.		-	71-7656	- 14 - 00

(1.300mm)

### Atom low voltage 29 N

14  60



BODY MAT AL IP20 100 50000h L90 B10 2 MacAdam 1% Ripple 90° 360°

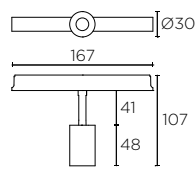

LED CREE

K	CRI	W	Real lm	Beam	Part No.
2700	90	3,1	269	24°	35-7285
3000	90	3,1	269	24°	35-7286

48VDC

#### Photometric data / Fotometría

LED CRI90 3000K 3,1W 24°

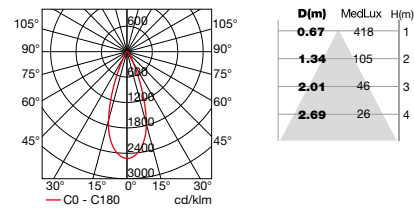

### Atom low voltage 52 N

14  60



BODY MAT AL IP20 100 60000h L90 B10 2 MacAdam 1% Ripple 90° 360°

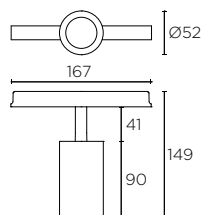

LED CREE

K	CRI	W	Real lm	Beam	Part No.
2700	90	12,1	853	24°	35-7279
			928	33°	35-7280
			778	43°	35-7281
3000	90	12,1	853	24°	35-7282
			928	33°	35-7283
			778	43°	35-7284

48VDC

#### Not included / No incluido

- |  |   |
|--|---|
| <input type="checkbox"/> 50                            | <input type="checkbox"/> 100  |
| Visual Comfort Confort visual <b>71-6276 - 60 - 00</b> | 5 x Elliptical Diffuser 5 x Difusor eliptico <b>71-6274 - 00 - 00</b> |
| Visor Visera <b>71-6277 - 60 - 00</b>                  | 5 x Honeycomb 5 x Panel de abeja <b>71-6273 - 60 - 00</b>             |
| Front ring Aro frontal <b>71-6436 - 14 - 00</b><br>23  | 5 x Softening Lens 5 x Difuminador de halo <b>71-6275 - 00 - 00</b>   |

#### Photometric data / Fotometría

LED CRI90 3000K 12,1W 24°

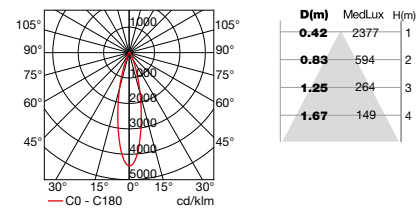

LED CRI90 3000K 12,1W 33°

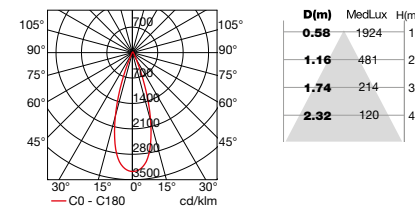

LED CRI90 3000K 12,1W 43°

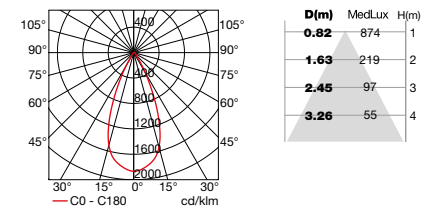

### Vela low voltage N

BODY MAT AL IP20 50 50000h L90 B10 2 MacAdam 1% Ripple

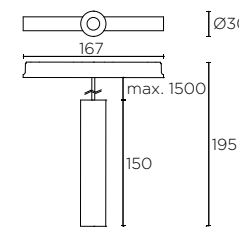

LED CREE

K	CRI	W	Real lm	Beam	Part No.
2700	90	3,1	269	24°	00-7341
3000	90	3,1	269	24°	00-7342

48VDC

#### Photometric data / Fotometría

LED CRI90 3000K 3,1W 24°

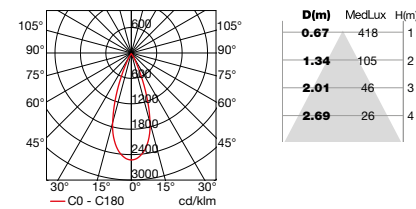

### Infinite low voltage N

BODY MAT AL DIF.MAT PVC IP20 50000h L70 B30 3 MacAdam

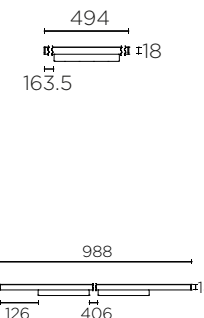
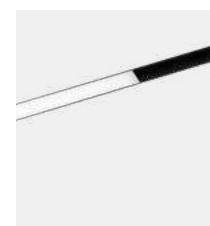

LED

K	CRI	W	Real lm	Part No.
2700	90	6,5	272	90-7359
3000	90	6,5	290	90-7361

48VDC 100

LED

K	CRI	W	Real lm	Part No.
2700	90	13	544	90-7360
3000	90	13	581	90-7362

48VDC 50

## Track low voltage surface N

■ 60



BODY MAT AL / ST ⊕ IP20

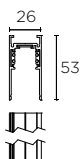

mm	
1000	<b>71-7624</b>
2000	<b>71-7625 - 60 - 00</b>
3000	<b>71-7626</b>

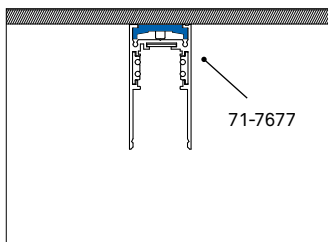

Installation / Instalación

### Connection accessories / Accesorios de conexión

	Surface installation kit (1 unit per profile)	Kit instalación superficie (1 unidad por perfil)	<b>71-7677 - 00 - 00</b>
	"I" surface union kit	Kit unión "I" superficie	<b>71-7639 - 60 - 00</b>
	L-shape connector right	Conector "L" derecho	<b>71-7627 - 60 - 00</b>
	L-shape connector left	Conector "L" izquierdo	<b>71-7675 - 60 - 00</b>
	Mains connector right	Acometida derecha	<b>71-7637 - 60 - 00</b>
	Mains connector left	Acometida izquierda	<b>71-7638 - 60 - 00</b>
	Covers kit	Kit tapas	<b>71-7705 - 00 - 00</b>

### Power supply / Fuente de Alimentación



(71-7648)

W	IP		
150	20	⊕	<b>71-7646 - 00 - 00</b>
240	67	⊞	<b>71-7647 - 00 - 00</b>
240	67	⊞	DIN 35mm <b>71-7648 - 00 - 00</b>

⊞ 100-240V 50-60Hz

## Track low voltage pendant N

■ 60



BODY MAT AL / ST ⊕ IP20

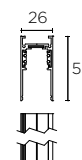
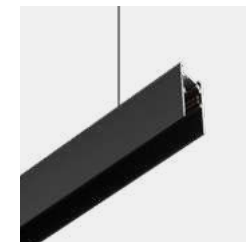

mm	
1000	<b>71-7624</b>
2000	<b>71-7625 - 60 - 00</b>
3000	<b>71-7626</b>

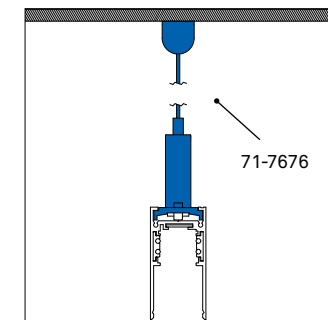

Installation / Instalación

### Connection accessories / Accesorios de conexión

	Suspended installation kit (1 unit per profile)	Kit instalación suspendido (1 unidad por perfil)	<b>71-7676 - 00 - 00</b>
	"I" suspended union kit	Kit unión "I" suspendido	<b>71-7629 - 60 - 00</b>
	L-shape connector right	Conector "L" derecho	<b>71-7627 - 60 - 00</b>
	L-shape connector left	Conector "L" izquierdo	<b>71-7675 - 60 - 00</b>
	Mains connector right	Acometida derecha	<b>71-7637 - 60 - 00</b>
	Mains connector left	Acometida izquierda	<b>71-7638 - 60 - 00</b>
	Covers kit	Kit tapas	<b>71-7705 - 00 - 00</b>
	Suspension with mains supply	Suspensión con toma de corriente	<b>71-7520 - 14 60 - 00</b>

### Power supply / Fuente de Alimentación



(71-7648)

W	IP		
150	20	⊕	<b>71-7646 - 00 - 00</b>
240	67	⊞	<b>71-7647 - 00 - 00</b>
240	67	⊞	DIN 35mm <b>71-7648 - 00 - 00</b>

⊞ 100-240V 50-60Hz

Track low voltage recessed **N**

60



BODY.MAT AL / ST IP20

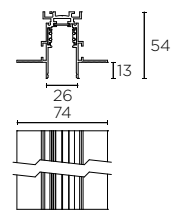
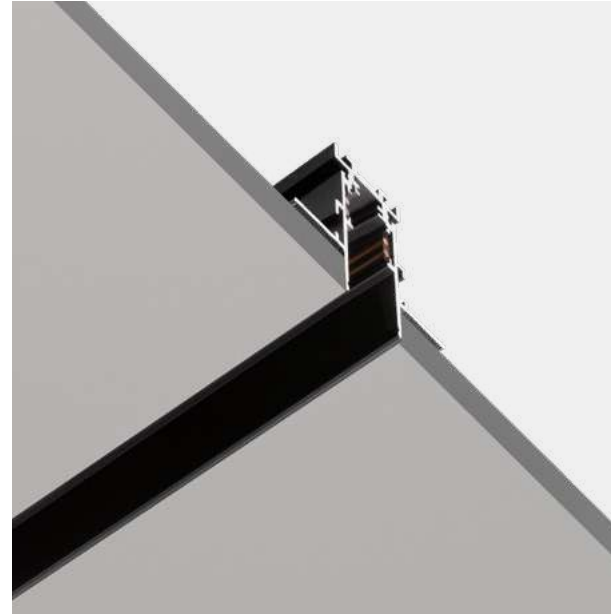

mm		
1000	54x1000	<b>71-7630</b>
2000	54x2000	<b>71-7631 - 60 - 00</b>
3000	54x3000	<b>71-7632</b>

± 0-13,3mm

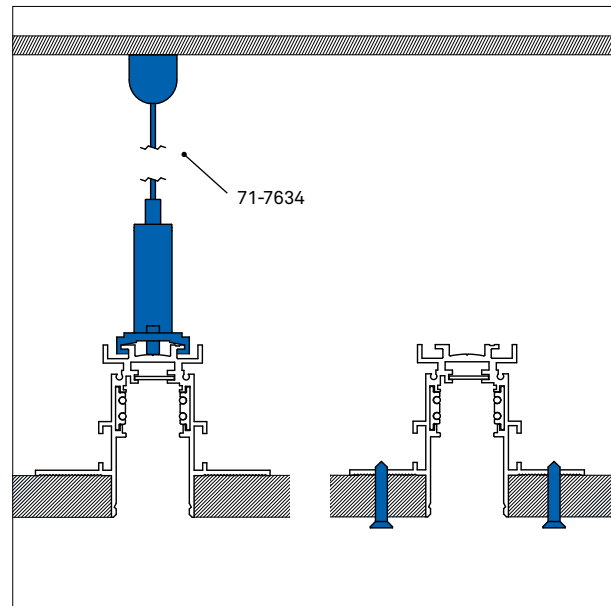

Installation / Instalación

Connection accessories / Accesorios de conexión

	Recessed installation kit (1 unit per profile) / Kit instalación empotrado (1 unidad por perfil)	<b>71-7634 - 00 - 00</b>
	"I" recessed union kit / Kit unión "I" empotrado	<b>71-7633 - 60 - 00</b>
	L-shape connector right / Conector "L" derecho	<b>71-7706 - 60 - 00</b>
	L-shape connector left / Conector "L" izquierdo	<b>71-7707 - 60 - 00</b>
	Mains connector right / Acometida derecha	<b>71-7637 - 60 - 00</b>
	Mains connector left / Acometida izquierda	<b>71-7638 - 60 - 00</b>
	Covers kit / Kit tapas	<b>71-7705 - 00 - 00</b>

Power supply / Fuente de Alimentación



(71-7648)

W	IP		
150	20	⊕	<b>71-7646 - 00 - 00</b>
240	67	⊖	<b>71-7647 - 00 - 00</b>
240	67	⊖	DIN 35mm <b>71-7648 - 00 - 00</b>

100-240V 50-60Hz

Play Deco Optics

Play Deco Optics

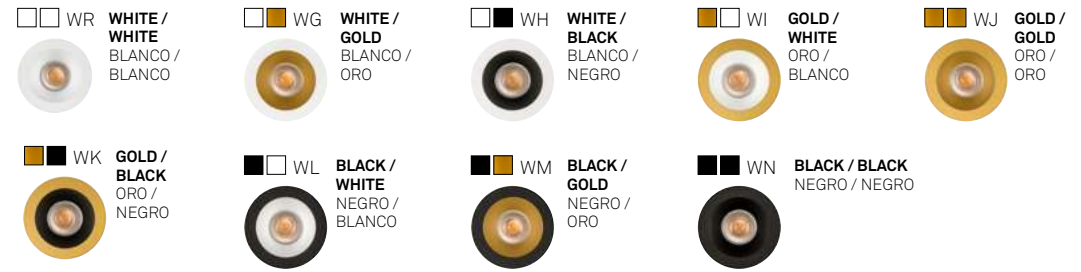

Configure your play  
http://play.leds-c4.com  
Configura tu play  
http://play.leds-c4.com

Symmetrical



TRIM  
0-15mm

AG23

Ø90  
7W H 92  
13W H 112  
18W H 132  
Ø80  
IP54

TRIMLESS  
0-25mm

AG24

Ø75  
7W H 91  
13W H 111  
18W H 131  
Ø75  
IP54



TRIM  
0-15mm

AG27

Ø100  
7W H 92  
13W H 112  
18W H 132  
Ø100  
IP54

TRIMLESS  
0-25mm

AG28

Ø75  
7W H 91  
13W H 111  
18W H 131  
75x75  
IP54

Asymmetrical



TRIM  
0-15mm

AG25

Ø90  
7W H 92  
13W H 108  
18W H 121  
Ø80  
IP54

TRIMLESS  
0-25mm

AG26

Ø75  
7W H 91  
13W H 107  
18W H 120  
Ø75  
IP54



TRIM  
0-15mm

AG29

Ø100  
7W H 92  
13W H 108  
18W H 121  
Ø100  
IP54

TRIMLESS  
0-25mm

AG31

Ø75  
7W H 91  
13W H 107  
18W H 120  
75x75  
IP54

Double



TRIM  
0-15mm



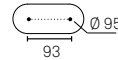

AG42

196 x 103  
7W H 93  
13W H 113  
18W H 133



±20° 320°  
IP23



MODEL MODELO	WATTAGE WATAJE	KELVIN / CRI	ANGLE ÁNGULO	SOURCE ALIMENTACIÓN	FINISH ACABADO
 <b>AG23</b> – SYMMETRICAL / WITH FRAME SIMÉTRICO / CON MARCO Ø90 Ø80	<b>P7</b> 7W	<b>V8</b> 2700K / CRI80 569lm (30°)	<b>S1</b> 10°	<b>BB</b>  ON-OFF PHASE CUT 0/1-10V / PUSH DALI 71-6651 71-7663 71-7710 71-6192	<b>WR</b>
		<b>W8</b> 3000K / CRI80 633lm (30°)	<b>S2</b> 15°		<b>WG</b>
		<b>X8</b> 4000K / CRI80 648lm (30°)	<b>M2</b> 30°		<b>WH</b>
 <b>AG27</b> – SYMMETRICAL / WITH FRAME SIMÉTRICO / CON MARCO Ø110 Ø100	<b>13</b> 13W	<b>V8</b> 2700K / CRI80 1249lm (30°)	<b>S1</b> 10°	<b>BB</b>  ON-OFF PHASE CUT 1-10V / PUSH/DALI 71-6652 71-5272 71-7710 71-6192	<b>WI</b>
		<b>V9</b> 2700K / CRI93 954lm (30°)	<b>S2</b> 15°		<b>WJ</b>
		<b>W8</b> 3000K / CRI80 1297lm (30°)	<b>M2</b> 30°		<b>WK</b>
 <b>AG25</b> – ASYMMETRICAL / WITH FRAME ASIMÉTRICO / CON MARCO Ø90 Ø80	<b>18</b> 18W	<b>V9</b> 2700K / CRI90 1707lm (30°)	<b>S1</b> 10°	<b>BB</b>  ON-OFF PHASE CUT 1-10V DALI 71-7551 71-7711 71-7710 71-6192	<b>WL</b>
		<b>W9</b> 3000K / CRI90 1707lm (30°)	<b>S2</b> 15°		<b>WM</b>
		<b>X9</b> 4000K / CRI90 1707lm (30°)	<b>M2</b> 30°		<b>WN</b>
 <b>AG29</b> – ASYMMETRICAL / WITH FRAME ASIMÉTRICO / CON MARCO Ø110 Ø100	<b>13</b> 13W	<b>S9</b> 2000-3000K / CRI90 897lm (30°)	<b>S1</b> 10°	<b>TS</b> PHASE CUT 220-240V	
			<b>S2</b> 15°		
			<b>M2</b> 30°		
			<b>F1</b> 50°		
<b>AA</b> GU10	<b>G1</b>	<b>NA</b>	<b>BU</b>		

Example of codification  
Ejemplo construcción referencia  
**AG23-P7V8S1BBWR**

Accessories / Accesorios



Elliptical Diffuser  
Difusor elíptico



Square diffuser  
Difusor cuadrado



Honeycomb  
Panel de abeja



Softening Lens  
Difuminador de halo



Visual Comfort  
Confort visual

Accessories not included / Accesorios no incluidos



**71-5167-00-00** Elliptical Diffuser x 5  
Difusor elíptico x 5



**71-5658-00-00** Square diffuser x 5  
Difusor cuadrado x 5



**71-5166-60-00** Honeycomb x 5  
Panel de abeja x 5 x 5



**71-6099-00-00** Softening Lens x 5  
Difuminador de halo x 5













**71-4754 - 14 - 00 60** Visual Comfort  
Confort visual

Play Deco Optics



BODY MAT AL / PC IP54 50000h L90 B10 2 MacAdam LED CREE LED SHARP (S9 - WARM DIMMING) CONTROL

MODEL MODELO	WATTAGE VATAJE	KELVIN / CRI	ANGLE ÁNGULO	SOURCE ALIMENTACIÓN	FINISH ACABADO
 <b>AG24 –</b> SYMMETRICAL / NO FRAME SIMÉTRICO / SIN MARCO Ø75 ∅75	P7 7W	V8 2700K / CRI80 569lm (30°)	S1 10°	BB  ON-OFF PHASE CUT 0/1-10V / PUSH DALI 71-6651 71-7663 71-7710 71-6192	WP  WS  WQ 
		W8 3000K / CRI80 633lm (30°)	S2 15°		
		X8 4000K / CRI80 648lm (30°)	M2 30°		
			F1 50°		
 <b>AG28 –</b> SYMMETRICAL / NO FRAME SIMÉTRICO / SIN MARCO 75 75x75	13 13W	V8 2700K / CRI80 1249lm (30°)	S1 10°	BB  ON-OFF PHASE CUT 1-10V 0/1-10V/PUSH/DALI 71-6652 71-5272 71-7710 71-6192	
		V9 2700K / CRI93 954lm (30°)	S2 15°		
		W8 3000K / CRI80 1297lm (30°)	M2 30°		
		X8 4000K / CRI80 1453lm (30°)	F1 50°		
 <b>AG26 –</b> ASYMMETRICAL / NO FRAME ASIMÉTRICO / SIN MARCO Ø75 ∅75	18 18W	V9 2700K / CRI90 1707lm (30°)	S1 10°	BB  ON-OFF PHASE CUT 1-10V DALI 71-7551 71-7711 71-7710 71-6192	
		W9 3000K / CRI90 1707lm (30°)	S2 15°		
		X9 4000K / CRI90 1707lm (30°)	M2 30°		
 <b>AG31 –</b> ASYMMETRICAL / NO FRAME ASIMÉTRICO / SIN MARCO 75 75x75	13 13W	S9 2000-3000K / CRI90 897lm (30°)	S1 10°	TS  PHASE CUT 220-240V 2000-3000K	
			S2 15°		
			M2 30°		
			F1 50°		
<b>AA</b> GU10	<b>G1</b>	<b>NA</b>	<b>BU</b>		

Example of codification  
Ejemplo construcción referencia

AG24-P7V8S1BBWP

 P.213











Accessories not included / Accesorios no incluidos

-  **71-5167-00-00** Elliptical Diffuser x 5 / Difusor elíptico x 5
-  **71-5166-60-00** Honeycomb x 5 / Panel de abeja x 5
-  **71-4754 - 14 - 00 60** Visual Comfort / Confort visual
-  **71-5658-00-00** Square diffuser x 5 / Difusor cuadrado x 5
-  **71-6099-00-00** Softening Lens x 5 / Difuminador de halo x 5

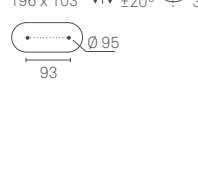
Play Deco Optics



BODY MAT AL / PC IP23 50000h L90 B10 2 MacAdam LED CREE LED SHARP (S9 - WARM DIMMING) CONTROL

MODEL MODELO	WATTAGE VATAJE	KELVIN / CRI	ANGLE ÁNGULO	SOURCE ALIMENTACIÓN	FINISH ACABADO
 <b>AG42 –</b> DOUBLE / WITH FRAME DOBLE / CON MARCO 196 x 103 ±20° 320° 93 0.95	P7 2 x 7W	V8 2700K / CRI80 569lm x 2 (30°)	S1 10°	BB  ON-OFF PHASE CUT 0/1-10V / PUSH DALI 2 x 71-6651 2 x 71-7663 2 x 71-7710 2 x 71-6192	14  23  60 
		W8 3000K / CRI80 633lm x 2 (30°)	S2 15°		
		X8 4000K / CRI80 648lm x 2 (30°)	M2 30°		
			F1 50°		
 <b>AG42 –</b> DOUBLE / WITH FRAME DOBLE / CON MARCO 196 x 103 ±20° 320° 93 0.95	13 2 x 13W	V8 2700K / CRI80 1249lm x 2 (30°)	S1 10°	BB  ON-OFF PHASE CUT 1-10V 0/1-10V/PUSH/DALI 2 x 71-6652 2 x 71-5272 2 x 71-7710 2 x 71-6192	
		V9 2700K / CRI93 954lm x 2 (30°)	S2 15°		
		W8 3000K / CRI80 1297lm x 2 (30°)	M2 30°		
		X8 4000K / CRI80 1453lm x 2 (30°)	F1 50°		
 <b>AG42 –</b> DOUBLE / WITH FRAME DOBLE / CON MARCO 196 x 103 ±20° 320° 93 0.95	18 2 x 18W	V9 2700K / CRI90 1707lm x 2 (30°)	S1 10°	BB  ON-OFF PHASE CUT 1-10V DALI 2 x 71-7551 2 x 71-7711 2 x 71-7710 2 x 71-6192	
		W9 3000K / CRI90 1707lm x 2 (30°)	S2 15°		
		X9 4000K / CRI90 1707lm x 2 (30°)	M2 30°		
 <b>AG42 –</b> DOUBLE / WITH FRAME DOBLE / CON MARCO 196 x 103 ±20° 320° 93 0.95	13 2 x 13W	S9 2000-3000K / CRI90 897lm x 2 (30°)	S1 10°	TS  PHASE CUT 220-240V 2000-3000K	
			S2 15°		
			M2 30°		
			F1 50°		
<b>AA</b> GU10	<b>G1</b>	<b>NA</b>	<b>BU</b>		

Example of codification  
Ejemplo construcción referencia

AG42-P7V8S1BB14

 P.213

Accessories not included / Accesorios no incluidos

-  **71-5167-00-00** Elliptical Diffuser x 5 / Difusor elíptico x 5
-  **71-5166-60-00** Honeycomb x 5 / Panel de abeja x 5
-  **71-4754 - 14 - 00 60** Visual Comfort / Confort visual
-  **71-5658-00-00** Square diffuser x 5 / Difusor cuadrado x 5
-  **71-6099-00-00** Softening Lens x 5 / Difuminador de halo x 5

# Play Surface Optics



Configure your play  
http://play.leds-c4.com  
Configura tu play  
http://play.leds-c4.com



BODY MAT AL / PC IP23 50000h L80 B20 2 MacAdam 30° LED CREE CONTROL

MODEL MODELO	WATTAGE VATAJE	KELVIN / CRI	ANGLE ÁNGULO	SOURCE ALIMENTACIÓN	FINISH ACABADO	
<b>AG32 –</b> SURFACE / FIXED SUPERFICIE / FIJO Ø72,5 H200	<b>P7</b> 7W	<b>V8</b> 2700K / CRI80 517lm (30°)	<b>S1</b> 10°	<b>NU</b> ON/OFF 100-240V	<b>WR</b>	
		<b>W8</b> 3000K / CRI80 548lm (30°)	<b>S2</b> 15°	<b>TS</b> PHASE CUT 220-240V	<b>WG</b>	
		<b>X8</b> 4000K / CRI80 603lm (30°)	<b>M2</b> 30°		<b>WH</b>	
			<b>F1</b> 50°		<b>WL</b>	
		<b>13</b> 13W	<b>V8</b> 2700K / CRI80 1100lm (30°)	<b>S1</b> 10°	<b>NU</b> ON/OFF 100-240V	<b>WM</b>
			<b>W8</b> 3000K / CRI80 1166lm (30°)	<b>S2</b> 15°	<b>TS</b> PHASE CUT 220-240V	<b>WN</b>
	<b>X8</b> 4000K / CRI80 1311lm (30°)		<b>M2</b> 30°			
			<b>F1</b> 50°			

Example of codification  
Ejemplo construcción referencia

AG32-P7V8S1NUWR

Not included / No incluido

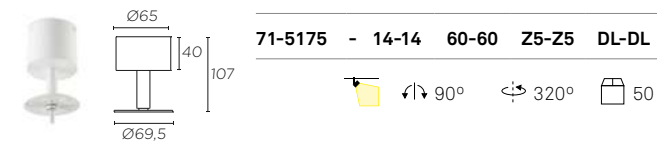
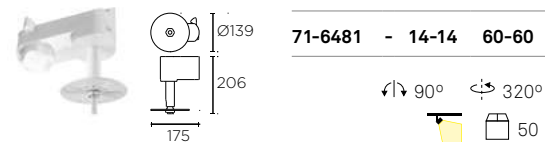

# Play Optics



## Fixed



## Adjustable

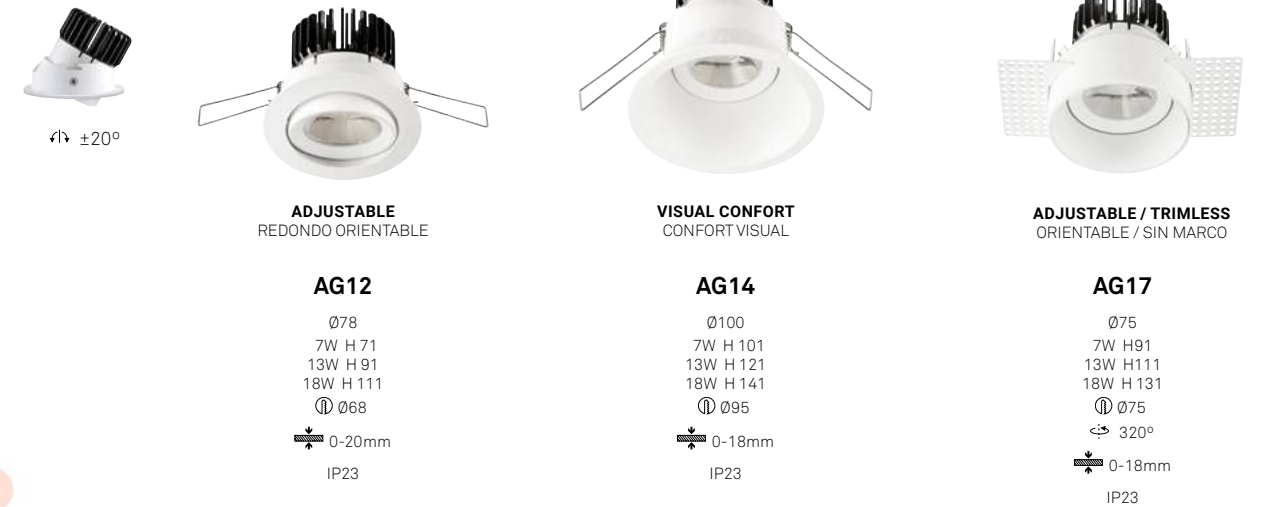



Play Optics

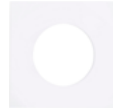

Fixed



**FIXED**  
FIJO

**AG19**

Ø65  
7W H 67  
13W H 87  
18W H 107  
Ø58  
0-7mm  
IP54



**IP65**  
CUADRADO IP65

**AG22**

Ø93  
7W H 82  
13W H 102  
18W H 122  
Ø65  
0-20mm  
IP65



**SQUARE IP65 C GLASS**  
CUADRADO IP65 CRISTAL

**AG44**

Ø92  
7W H 98  
13W H 98  
18W H 125  
Ø68  
0-20mm  
IP65

Adjustable



±20°



**ADJUSTABLE**  
ORIENTABLE

**AG21**

Ø78  
7W H 71  
13W H 91  
18W H 111  
Ø68  
0-20mm  
IP23

ACCESSORIES  
ACCESORIOS



Elliptical Diffuser  
Difusor elíptico



Square diffuser  
Difusor cuadrado



Honeycomb  
Panel de abeja



Softening Lens  
Difuminador de halo



Visual Comfort  
Difuminador de halo

Play Optics



Configure your play  
http://play.leds-c4.com  
Configura tu play  
http://play.leds-c4.com

14 WHITE  
BLANCO



60 BLACK  
NEGRO



21 CHROME  
CROMO



AF SATIN ALUMINIUM  
ALUMINIO SATINADO



BODY MAT AL / PC 50000h L90 B10 2 MacAdam LED CREE LED SHARP (S9 - WARM DIMMING) CONTROL

MODEL MODELO	WATTAGE VATAJE	KELVIN / CRI	ANGLE ÁNGULO	SOURCE ALIMENTACIÓN	FINISH ACABADO
<b>AG16</b> — IP65 REDONDO IP65 Ø93 Ø65 IP65	<b>P7</b> 7W	<b>V8</b> 2700K / CRI80 569lm (30°)	<b>S1</b> 10°	<b>BB</b>  ON-OFF 71-6651 PHASE CUT 71-7663 0/1-10V / PUSH 71-7710 DALI 71-6192	<b>14</b>
		<b>W8</b> 3000K / CRI80 633lm (30°)	<b>S2</b> 15°		<b>60</b>
		<b>X8</b> 4000K / CRI80 648lm (30°)	<b>M2</b> 30°		<b>21</b>
	<b>13</b> 13W	<b>V8</b> 2700K / CRI80 1249lm (30°)	<b>S1</b> 10°	<b>BB</b>  ON-OFF 71-6652 PHASE CUT 71-5272 1-10V 71-7710 0/1-10V/PUSH/DALI 71-6192	<b>AF</b>
		<b>V9</b> 2700K / CRI93 954lm (30°)	<b>S2</b> 15°		
		<b>W8</b> 3000K / CRI80 1297lm (30°)	<b>M2</b> 30°		
	<b>18</b> 18W	<b>V9</b> 2700K / CRI90 1707lm (30°)	<b>S1</b> 10°	<b>BB</b>  ON-OFF 71-7551 PHASE CUT 71-7711 1-10V 71-7710 DALI 71-6192	
		<b>W9</b> 3000K / CRI90 1707lm (30°)	<b>S2</b> 15°		
		<b>X9</b> 4000K / CRI90 1707lm (30°)	<b>M2</b> 30°		
	<b>13</b> 13W	<b>S9</b> 2000-3000K / CRI90 897lm (30°)	<b>S1</b> 10°	<b>TS</b> PHASE CUT 220-240V	
			<b>S2</b> 15°		
			<b>M2</b> 30°		
	<b>AA</b> GU10		<b>F1</b> 50°		
		<b>G1</b>	<b>NA</b>	<b>BU</b>	

Example of codification  
Ejemplo construcción referencia

AG16-P7V8S1BB14

P. 213

Accessories not included / Accesorios no incluidos

71-5167-00-00 Elliptical Diffuser x 5  
Difusor elíptico x 5

71-5166-60-00 Honeycomb x 5  
Panel de abeja x 5

71-4754 - 14 - 00 Visual Comfort  
60 Confort visual

71-5658-00-00 Square diffuser x 5  
Difusor cuadrado x 5

71-6099-00-00 Softening Lens x 5  
Difuminador de halo x 5

Play Optics



Configure your play  
http://play.leds-c4.com  
Configura tu play  
http://play.leds-c4.com

14 WHITE  
BLANCO



60 BLACK  
NEGRO



AF SATIN ALUMINIUM  
ALUMINIO SATINADO



BODY MAT AL / PC 50000h L90 B10 2 MacAdam LED CREE LED SHARP (S9 - WARM DIMMING)



MODEL MODELO	WATTAGE VATAJE	KELVIN / CRI	ANGLE ÁNGULO	SOURCE ALIMENTACIÓN	FINISH ACABADO
<b>AG11</b> – FIXED FIJO Ø65 Ø58 IP54	<b>P7</b> 7W	<b>V8</b> 2700K / CRI80 569lm (30°)	<b>S1</b> 10°	<b>BB</b> ON-OFF PHASE CUT 0/1-10V / PUSH DALI 71-6651 71-7663 71-7710 71-6192	<b>14</b> <b>60</b> <b>AF</b>
		<b>W8</b> 3000K / CRI80 633lm (30°)	<b>S2</b> 15°		
		<b>X8</b> 4000K / CRI80 648lm (30°)	<b>M2</b> 30° <b>F1</b> 50°		
<b>AG12</b> – ADJUSTABLE REDONDO ORIENTABLE Ø78 Ø68 IP23 ±20°	<b>13</b> 13W	<b>V8</b> 2700K / CRI80 1249lm (30°)	<b>S1</b> 10°	<b>BB</b>	
		<b>V9</b> 2700K / CRI93 954lm (30°)	<b>S2</b> 15°		
		<b>W8</b> 3000K / CRI80 1297lm (30°)	<b>M2</b> 30° <b>F1</b> 50°		
<b>AG15</b> – DEEP PROFUNDO Ø65 Ø58 IP54	<b>18</b> 18W	<b>V9</b> 2700K / CRI90 1707lm (30°)	<b>S1</b> 10°	<b>BB</b>	
		<b>W9</b> 3000K / CRI90 1707lm (30°)	<b>S2</b> 15°		
		<b>X9</b> 4000K / CRI90 1707lm (30°)	<b>M2</b> 30° <b>F1</b> 50°		
<b>AG19</b> – FIXED FIJO Ø65 Ø58 IP54	<b>13</b> 13W	<b>S9</b> 2000-3000K / CRI90 897lm (30°)	<b>S1</b> 10°	<b>TS</b> PHASE CUT 220-240V	
			<b>S2</b> 15°		
			<b>M2</b> 30° <b>F1</b> 50°		
<b>AG21</b> – ADJUSTABLE ORIENTABLE Ø78 Ø68 IP23 ±20°	<b>AA</b> GU10	<b>G1</b>	<b>NA</b>	<b>BU</b>	
			<b>NA</b>		
			<b>BU</b>		
<b>AG22</b> – IP65 CUADRADO IP65 Ø93 Ø65 IP65	<b>AA</b> GU10	<b>G1</b>	<b>NA</b>	<b>BU</b>	
			<b>NA</b>		
			<b>BU</b>		

Example of codification  
Ejemplo construcción referencia

AG11-P7V8S1BB14

Accessories not included / Accesorios no incluidos

71-5167-00-00 Elliptical Diffuser x 5  
Difusor elíptico x 5

71-5166-60-00 Honeycomb x 5  
Panel de abeja x 5

71-4754 - 14 - 00  
60 Visual Comfort  
Confort visual

71-5658-00-00 Square diffuser x 5  
Difusor cuadrado x 5

71-6099-00-00 Softening Lens x 5  
Difuminador de halo x 5

Play Optics



Configure your play  
http://play.leds-c4.com  
Configura tu play  
http://play.leds-c4.com

14 WHITE  
BLANCO



60 BLACK  
NEGRO



BODY MAT AL / PC 50000h L90 B10 2 MacAdam LED CREE LED SHARP (S9 - WARM DIMMING)



MODEL MODELO	WATTAGE VATAJE	KELVIN / CRI	ANGLE ÁNGULO	SOURCE ALIMENTACIÓN	FINISH ACABADO
<b>AG13</b> – VISUAL CONFORT CONFORT VISUAL Ø90 Ø78 IP54	<b>P7</b> 7W	<b>V8</b> 2700K / CRI80 569lm (30°)	<b>S1</b> 10°	<b>BB</b> ON-OFF PHASE CUT 0/1-10V / PUSH DALI 71-6651 71-7663 71-7710 71-6192	<b>AG13/ AG14/ AG17/ AG43/ AG44</b> <b>14</b> <b>AG13/ AG14/ AG17</b> <b>60</b>
		<b>W8</b> 3000K / CRI80 633lm (30°)	<b>S2</b> 15°		
		<b>X8</b> 4000K / CRI80 648lm (30°)	<b>M2</b> 30° <b>F1</b> 50°		
<b>AG14</b> – VISUAL CONFORT CONFORT VISUAL Ø100 Ø95 IP23 ±20°	<b>13</b> 13W	<b>V8</b> 2700K / CRI80 1249lm (30°)	<b>S1</b> 10°	<b>BB</b>	
		<b>V9</b> 2700K / CRI93 954lm (30°)	<b>S2</b> 15°		
		<b>W8</b> 3000K / CRI80 1297lm (30°)	<b>M2</b> 30° <b>F1</b> 50°		
<b>AG17</b> – ADJUSTABLE / TRIMLESS ORIENTABLE/ SIN MARCO Ø75 Ø75 IP23 ±20° ±320°	<b>18</b> 18W	<b>V9</b> 2700K / CRI90 1707lm (30°)	<b>S1</b> 10°	<b>BB</b>	
		<b>W9</b> 3000K / CRI90 1707lm (30°)	<b>S2</b> 15°		
		<b>X9</b> 4000K / CRI90 1707lm (30°)	<b>M2</b> 30° <b>F1</b> 50°		
<b>AG43</b> – SQUARE IP65 C GLASS CUADRADO IP65 CRISTAL Ø92 Ø68 IP65	<b>13</b> 13W	<b>S9</b> 2000-3000K / CRI90 897lm (30°)	<b>S1</b> 10°	<b>TS</b> PHASE CUT 220-240V	
			<b>S2</b> 15°		
			<b>M2</b> 30° <b>F1</b> 50°		
<b>AG44</b> – ROUND IP65 GLASS REDONDO IP65 CRISTAL Ø92 Ø68 IP65	<b>AA</b> GU10	<b>G1</b>	<b>NA</b>	<b>BU</b>	
			<b>NA</b>		
			<b>BU</b>		

Example of codification  
Ejemplo construcción referencia

AG13-P7V8S1BB14

Accessories not included / Accesorios no incluidos

71-5167-00-00 Elliptical Diffuser x 5  
Difusor elíptico x 5

71-5166-60-00 Honeycomb x 5  
Panel de abeja x 5

71-4754 - 14 - 00  
60 Visual Comfort  
Confort visual

71-5658-00-00 Square diffuser x 5  
Difusor cuadrado x 5

71-6099-00-00 Softening Lens x 5  
Difuminador de halo x 5

Play Optics

14 WHITE BLANCO



Configure your play  
http://play.leds-c4.com  
Configura tu play  
http://play.leds-c4.com

BODY MAT AL / PC 50000h L90 B10 2 MacAdam LED CREE LED SHARP (S9 - WARM DIMMING) CONTROL



**AG18 -**  
FIRE-RESISTANT  
RESISTENTE AL FUEGO  
Ø97 Ø88 IP54

MODEL MODELO	WATTAGE VATAJE	KELVIN / CRI	ANGLE ÁNGULO	SOURCE ALIMENTACIÓN	FINISH ACABADO
AG18 - FIRE-RESISTANT RESISTENTE AL FUEGO Ø97 Ø88 IP54	P7 7W	V8 2700K / CRI80 569lm (30°)	S1 10°	BB	14
		W8 3000K / CRI80 633lm (30°)	S2 15°		
		X8 4000K / CRI80 648lm (30°)	M2 30°		
			F1 50°		
	13 13W	V8 2700K / CRI80 1249lm (30°)	S1 10°	BB	
		V9 2700K / CRI93 954lm (30°)	S2 15°		
		W8 3000K / CRI80 1297lm (30°)	M2 30°		
		X8 4000K / CRI80 1453lm (30°)	F1 50°		
AA GU10	G1	NA	BU		

ON-OFF 71-6651  
PHASE CUT 71-7663  
0/1-10V / PUSH 71-7710  
DALI 71-6192

ON-OFF 71-6652  
PHASE CUT 71-5272  
1-10V 71-7710  
0/1-10V/PUSH/DALI 71-6192

Example of codification  
Ejemplo construcción referencia

AG18-P7V8S1BB14

P.213

Accessories not included / Accesorios no incluidos

- 71-5167-00-00 Elliptical Diffuser x 5  
Difusor elíptico x 5
- 71-5166-60-00 Honeycomb x 5  
Panel de abeja x 5
- 71-4754 - 14 - 00 60 Visual Comfort  
Confort visual
- 71-6099-00-00 Softening Lens x 5  
Difuminador de halo x 5

Mini Play Optics



Fixed



FIXED / TRIM  
FIJO / CON MARCO

AG33

Ø45 H 39 Ø40  
0-8mm  
IP54



VISUAL COMFORT / FIXED / TRIM  
CONFORT VISUAL / FIJO / CON MARCO

AG36

Ø45 H 54 Ø40  
0-15mm  
IP54



IP65  
IP65



FIXED / TRIMLESS  
FIJO / SIN MARCO

AG37

Ø50 H 46 Ø40  
0-20mm  
IP65

AG41

Ø36 H 49 Ø36  
0-14,5mm  
IP54

Adjustable



±20°



ADJUSTABLE / TRIM  
ORIENTABLE / CON MARCO

AG34

Ø52 H 41 Ø42  
0-12mm  
IP23

ACCESSORIES  
ACCESORIOS



Kit recessed concrete housing  
Kit empotrado hormigón



Mini Play Optics N

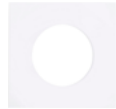

Mini Play Optics N

14 WHITE  
BLANCO



60 BLACK  
NEGRO



AF SATIN ALUMINIUM  
ALUMINIO SATINADO



Configure your play  
http://play.leds-c4.com  
Configura tu play  
http://play.leds-c4.com

BODY MAT AL / PC 50000h L80 B20 2 MacAdam LED CREE



Fixed



FIXED / TRIM  
FIJO / CON MARCO

AG38

∅45 H 39 ∅40

0-8mm

IP54

Adjustable



±20°



ADJUSTABLE / TRIM  
ORIENTABLE / CON MARCO

AG39

∅52 H 41 ∅42

0-12mm

IP23

MODEL MODELO	WATTAGE WATAJE	KELVIN / CRI	ANGLE ÁNGULO	SOURCE ALIMENTACIÓN	FINISH ACABADO	
AG33 — FIXED / TRIM FIJO / CON MARCO ∅45 ∅40 IP54	P3 3,2W	V8 2700K / CRI80 348lm (30°)	M2 30°	BB	14	
		W8 3000K / CRI80 376lm (30°)	F1 50°			60
		X8 4000K / CRI80 376lm (30°)				AF
AG34 — ADJUSTABLE / TRIM ORIENTABLE / CON MARCO ∅52 ∅42 IP23 ±20°				1 x 1 ON-OFF 71-7364		
				1 x max.7 ON-OFF 71-3542		
				1 x min.2 max.3 PHASE CUT 71-7709		
				1 x max.4 0/1-10V / PUSH 71-7710		
				DALI 71-6192		

P.213

Example of codification  
Ejemplo construcción referencia

AG33-P3V8M2BB14

Accessories not included / Accesorios no incluidos



71-5618-60-00 Kit recessed concrete housing ∅40-42/  
Kit empotrado hormigón para ∅40-42/

71-5617-60-00 Kit recessed concrete housing ∅36/  
Kit empotrado hormigón para ∅36/

Mini Play Optics



Configure your play  
http://play.leds-c4.com  
Configura tu play  
http://play.leds-c4.com

BODY MAT AL / PC 50000h L80 B20 2 MacAdam LED CREE

MODEL MODELO	WATTAGE VATAJE	KELVIN / CRI	ANGLE ÁNGULO	SOURCE ALIMENTACIÓN	FINISH ACABADO
<b>AG41 -</b> FIXED / TRIMLESS FIJO / SIN MARCO Ø36 Ø36 IP54	<b>P3</b> 3,2W	<b>V8</b> 2700K / CRI80 348lm (30°)	<b>M2</b> 30°	<b>BB</b>	<b>14</b>
		<b>W8</b> 3000K / CRI80 376lm (30°)	<b>F1</b> 50°		
		<b>X8</b> 4000K / CRI80 376lm (30°)	<b>60</b>		

1 x 1	
ON-OFF 71-7364	X
1 x max.7	
ON-OFF 71-3542	X
1 x min.2 max.3	
PHASE CUT 71-7709	X
1 x max.4	
0/1-10V / PUSH 71-7710	X
DALI 71-6192	X

P.213

Example of codification  
Ejemplo construcción referencia

AG41-P3V8M1BB14

Luno recessed



\* Please contact our sales team for conditions and delivery times.  
\* Consultar condiciones y plazos de entrega a nuestro equipo comercial.

BODY MAT AL DIF MAT PMMA IP20 50000h L80 B10

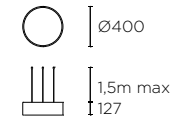

LED SAMSUNG					
K	CRI	W	Real lm	UGR	
3000	80	24,5	2389	<19	<b>90-5922</b>
4000	80	24,5	2389	<19	<b>90-5923</b>

**OU** ON/OFF 100-240V 50-60Hz  
**RU** 1-10V 100-240V 50-60Hz

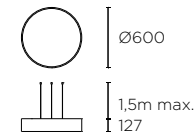

LED SAMSUNG					
K	CRI	W	Real lm	UGR	
3000	80	52	5083	<19	<b>90-5924</b>
4000	80	52	5083	<19	<b>90-5925</b>

**OU** ON/OFF 100-240V 50-60Hz  
**RU** 1-10V 100-240V 50-60Hz

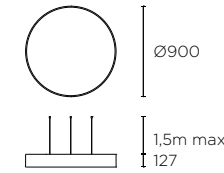

LED SAMSUNG					
K	CRI	W	Real lm	UGR	
3000	80	97	9687	<19	<b>90-5926</b>
4000	80	97	9687	<19	<b>90-5927</b>

**OU** ON/OFF 100-240V 50-60Hz  
**RU** 1-10V 100-240V 50-60Hz

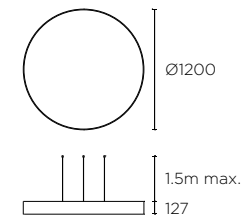

LED SAMSUNG					
K	CRI	W	Real lm	UGR	
3000	80	146	15065	<19	<b>90-5928</b>
4000	80	146	15065	<19	<b>90-5929</b>

**OU** ON/OFF 100-240V 50-60Hz  
**RU** 1-10V 100-240V 50-60Hz

Photometric data / Fotometría

LED CRI80 3000K 52W

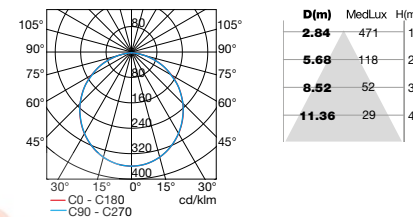

LED CRI80 3000K 97W

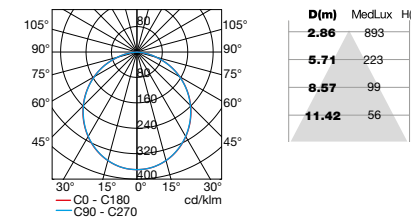

LED CRI80 3000K 146W

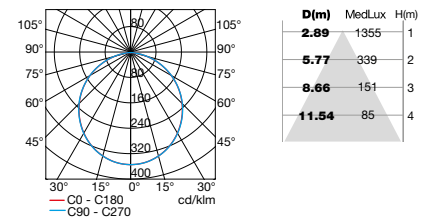

Accessories not included / Accesorios no incluidos



**71-5618-60-00** Kit recessed concrete housing Ø40-42/  
Kit empotrado hormigón para Ø40-42/

**71-5617-60-00** Kit recessed concrete housing Ø36/  
Kit empotrado hormigón para Ø36/

Luno surface



\* Please contact our sales team for conditions and delivery times.  
\* Consultar condiciones y plazos de entrega a nuestro equipo comercial.

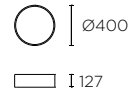
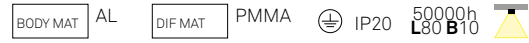

LED SAMSUNG

K	CRI	W	Real lm	UGR	
3000	80	24,5	2389	<19	<b>15-5922</b>
4000	80	24,5	2389	<19	<b>15-5923</b>

**OU** ON/OFF 100-240V 50-60Hz  
**RU** 1-10V 100-240V 50-60Hz



LED SAMSUNG

K	CRI	W	Real lm	UGR	
3000	80	52	5083	<19	<b>15-5924</b>
4000	80	52	5083	<19	<b>15-5925</b>

**OU** ON/OFF 100-240V 50-60Hz  
**RU** 1-10V 100-240V 50-60Hz

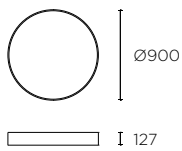

LED SAMSUNG

K	CRI	W	Real lm	UGR	
3000	80	97	9687	<19	<b>15-5926</b>
4000	80	97	9687	<19	<b>15-5927</b>

**OU** ON/OFF 100-240V 50-60Hz  
**RU** 1-10V 100-240V 50-60Hz

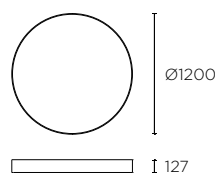

LED SAMSUNG

K	CRI	W	Real lm	
3000	80	146	15065	<b>15-5928</b>
4000	80	146	15065	<b>15-5929</b>

**OU** ON/OFF 100-240V 50-60Hz  
**RU** 1-10V 100-240V 50-60Hz

Photometric data / Fotometría

LED CRI80 3000K 52W

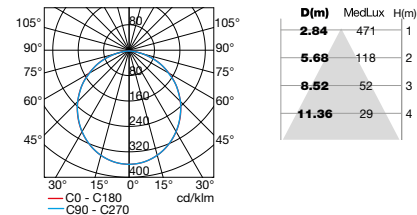

LED CRI80 3000K 97W

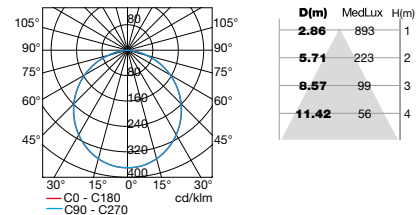

LED CRI80 3000K 146W

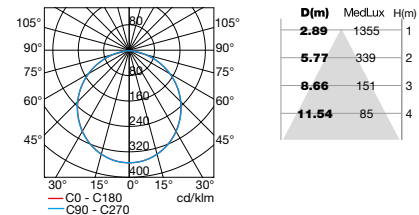

Luno pendant



\* Please contact our sales team for conditions and delivery times.  
\* Consultar condiciones y plazos de entrega a nuestro equipo comercial.

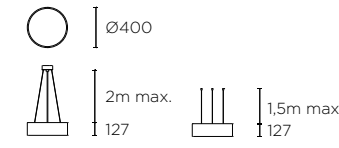
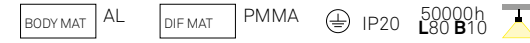

LED SAMSUNG

K	CRI	W	Real lm	UGR	
3000	80	24,5	2389	<19	<b>00-5922</b>
4000	80	24,5	2389	<19	<b>00-5923</b>

**OU** ON/OFF 100-240V 50-60Hz  
**RU** 1-10V 100-240V 50-60Hz

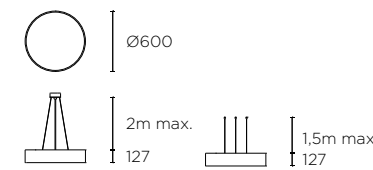

LED SAMSUNG

K	CRI	W	Real lm	UGR	
3000	80	52	5083	<19	<b>00-5924</b>
4000	80	52	5083	<19	<b>00-5925</b>

**OU** ON/OFF 100-240V 50-60Hz  
**RU** 1-10V 100-240V 50-60Hz

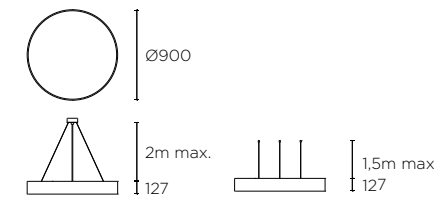

LED SAMSUNG

K	CRI	W	Real lm	UGR	
3000	80	97	9687	<19	<b>00-5926</b>
4000	80	97	9687	<19	<b>00-5927</b>

**OU** ON/OFF 100-240V 50-60Hz  
**RU** 1-10V 100-240V 50-60Hz

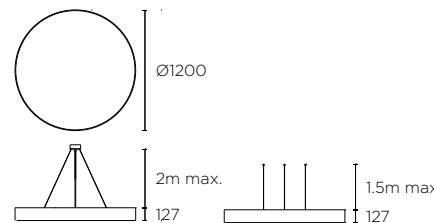

LED SAMSUNG

K	CRI	W	Real lm	
3000	80	146	15065	<b>00-5928</b>
4000	80	146	15065	<b>00-5929</b>

**OU** ON/OFF 100-240V 50-60Hz  
**RU** 1-10V 100-240V 50-60Hz

Photometric data / Fotometría

LED CRI80 3000K 52W

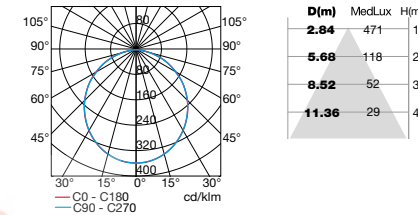

LED CRI80 3000K 97W

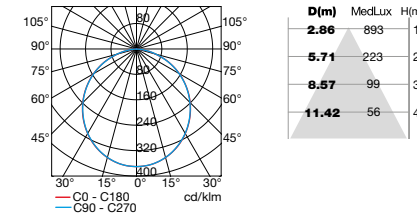

LED CRI80 3000K 146W

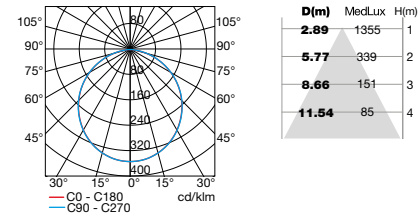

### Taglio di luce Direct

19 / 35 / 50 mm **TRIMLESS**  
**SIN MARCO**

19 / 35 mm **TRIM**  
**CON MARCO**

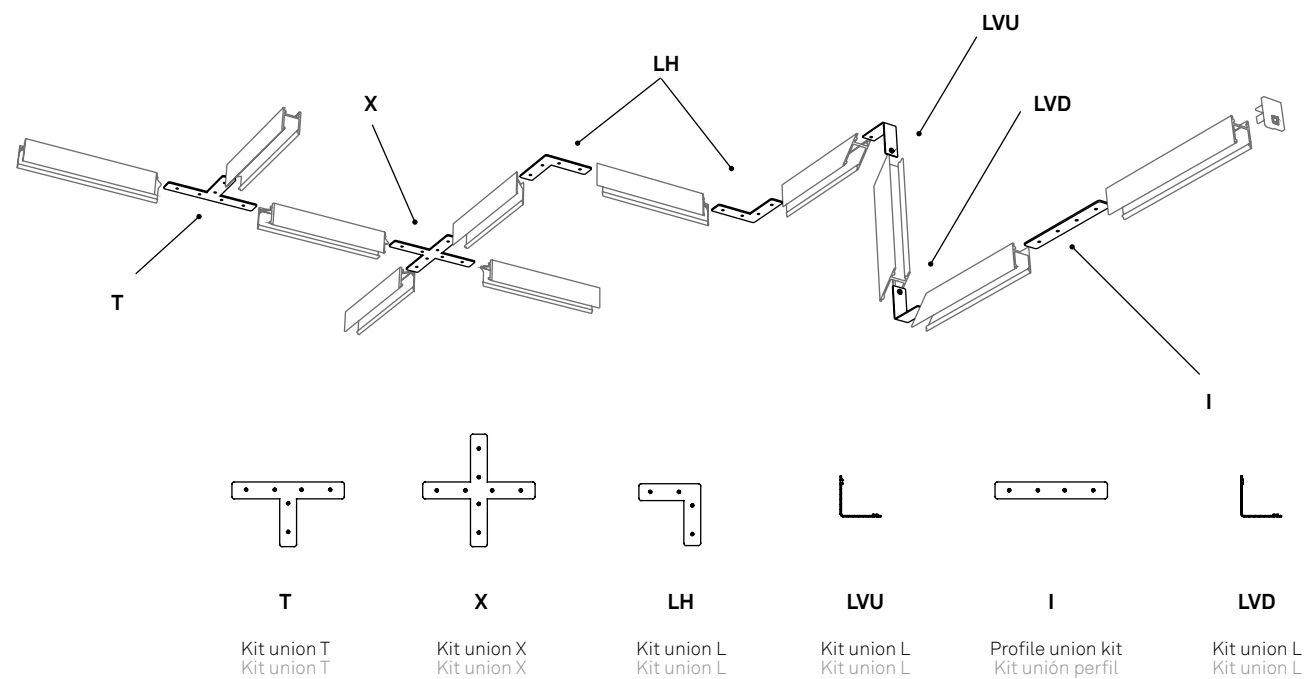

50 mm **TRIM**  
**CON MARCO**

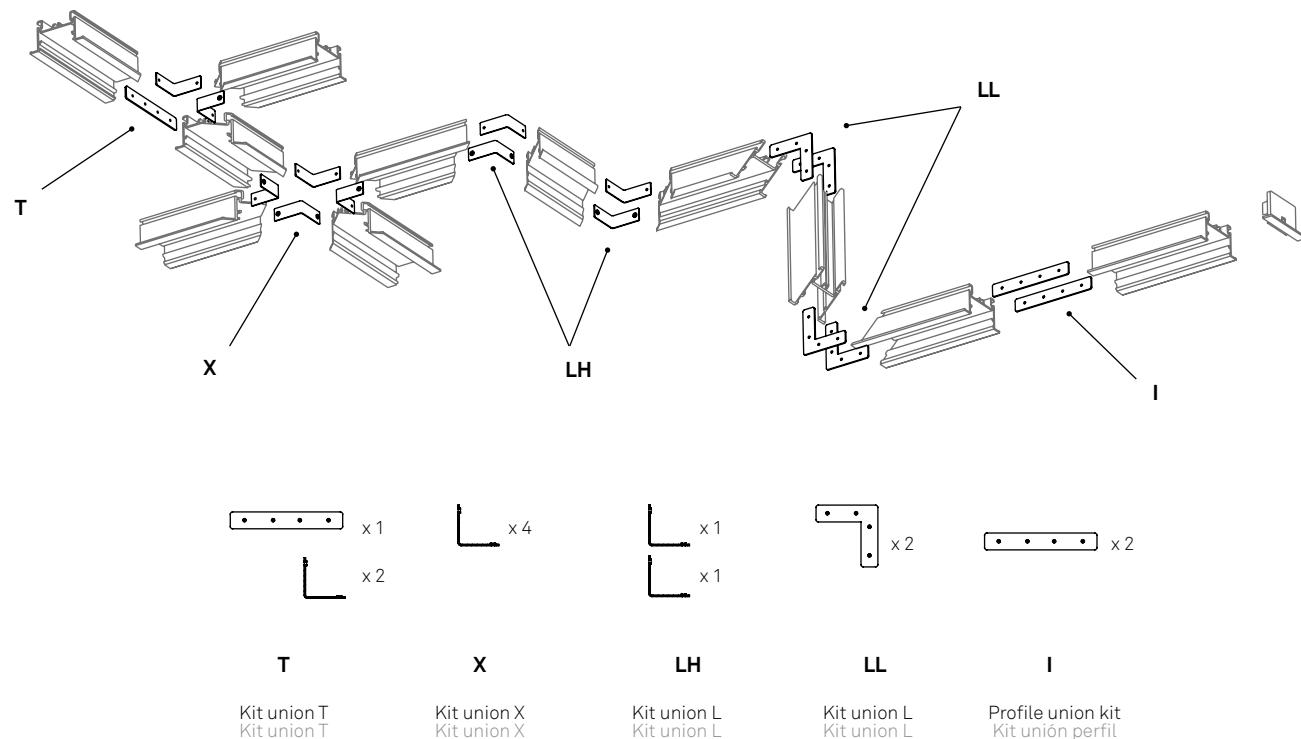

### Taglio di luce 19 mm

□ 14



BODY MAT ST IP20 RECOM LED STRIPS On HP / On PL / On SP

**TRIM**  
**CON MARCO**



L	
1000 mm	71-5738
2000 mm	71-5739 - 14 - 00
3000 mm	71-5740

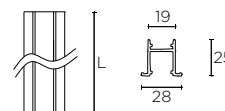

**TRIM** NOT INCLUDED / REQUIRED  
**CON MARCO** NO INCLUIDO / REQUERIDO

- 71-5765 - 14 - 00  
End cap / 2 units/ref  
Tapa final / 2 unidades/ref
- 71-5511 - 00 - 00  
Recessed kit 1000mm  
Kit para empotrar 1000mm  
□ 100

**TRIMLESS**  
**SIN MARCO**



L	
1000 mm	71-5741
2000 mm	71-5742 - 14 - 00
3000 mm	71-5743

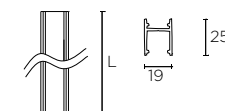

**TRIMLESS** NOT INCLUDED / REQUIRED  
**SIN MARCO** NO INCLUIDO / REQUERIDO

- 71-5766 - 14 - 00  
End cap / 2 units/ref  
Tapa final / 2 unidades/ref
- 71-5786 - 00 - 00  
Recessed kit 1000mm  
Kit para empotrar 1000mm

**TRIMLESS & TRIM** NOT INCLUDED / REQUIRED  
**SIN MARCO & CON MARCO** NO INCLUIDO / REQUERIDO



L	
1000 mm	71-5771
2000 mm	71-5772 - 00 - 00
3000 mm	71-5773
10000 mm	71-5774

□ DIF MAT PC  
Tinted diffuser  
Difusor Opal

**TRIMLESS & TRIM** NOT INCLUDED  
**SIN MARCO & CON MARCO** NO INCLUIDO

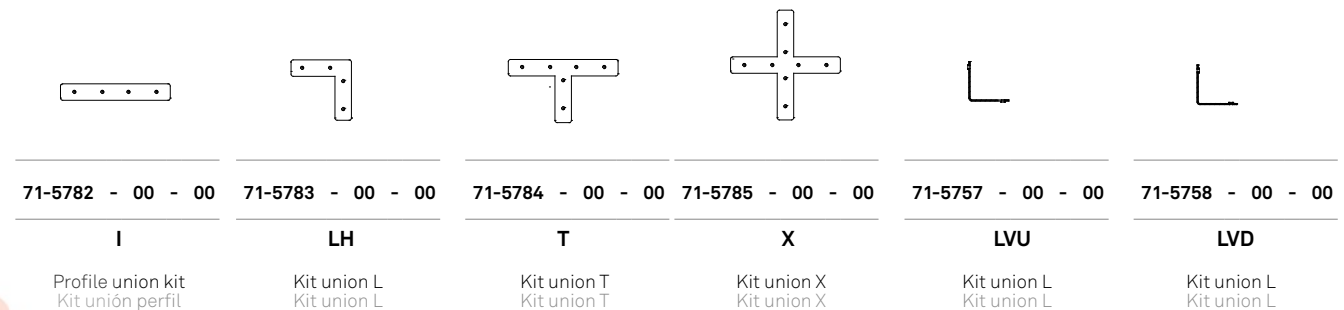

### Taglio di luce 35 mm

□ 14



BODY MAT AL IP20 RECOM LED STRIPS On HP / On PL / On SP

#### TRIM CON MARCO



L	
1000 mm	71-5744
2000 mm	71-5745 - 14 - 00
3000 mm	71-5746

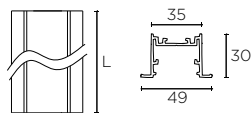

#### TRIMLESS SIN MARCO



L	
1000 mm	71-5747
2000 mm	71-5748 - 14 - 00
3000 mm	71-5749

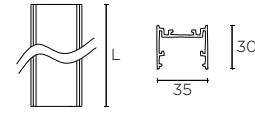

#### TRIM NOT INCLUDED / REQUIRED CON MARCO NO INCLUIDO / REQUERIDO

**71-5767 - 14 - 00**  
End cap / 2 units/ref  
Tapa final / 2 unidades/ref

**71-5511 - 00 - 00**  
Recessed kit 1000mm  
Kit para empotrar 1000mm  
100

#### TRIMLESS NOT INCLUDED / REQUIRED SIN MARCO NO INCLUIDO / REQUERIDO

**71-5768 - 14 - 00**  
End cap / 2 units/ref  
Tapa final / 2 unidades/ref

**71-5787 - 00 - 00**  
Recessed kit 1000mm  
Kit para empotrar 1000mm

#### TRIMLESS & TRIM NOT INCLUDED / REQUIRED SIN MARCO & CON MARCO NO INCLUIDO / REQUERIDO

**71-5775**  
**71-5776**  
**71-5777 - 00 - 00**  
**71-5778**  
Tinted diffuser  
Difusor Opal

#### TRIMLESS & TRIM NOT INCLUDED SIN MARCO & CON MARCO NO INCLUIDO

<b>71-5782 - 00 - 00</b>	<b>71-5783 - 00 - 00</b>	<b>71-5784 - 00 - 00</b>	<b>71-5785 - 00 - 00</b>	<b>71-5757 - 00 - 00</b>	<b>71-5758 - 00 - 00</b>
I	LH	T	X	LVU	LVD

Profile union kit Kit unión perfil    Kit union L Kit union L    Kit union T Kit union T    Kit union X Kit union X    Kit union L Kit union L    Kit union L Kit union L

### Taglio di luce 50 mm

□ 14



BODY MAT AL IP20 RECOM LED STRIPS On HP / On PL / On SP

#### TRIM CON MARCO



L	
1000 mm	71-5750
2000 mm	71-5751 - 14 - 00
3000 mm	71-5752

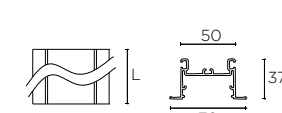

#### TRIM NOT INCLUDED / REQUIRED CON MARCO NO INCLUIDO / REQUERIDO

**71-5769 - 14 - 00**  
End cap / 2 units/ref  
Tapa final / 2 unidades/ref

**71-5512 - 00 - 00**  
Recessed kit 1000mm  
Kit para empotrar 1000mm

#### TRIM NOT INCLUDED / REQUIRED CON MARCO NO INCLUIDO / REQUERIDO

**71-5779**  
**71-5780 - 00 - 00**  
**71-5781**  
**71-5486**  
Tinted diffuser  
Difusor Opal

#### TRIM NOT INCLUDED CON MARCO NO INCLUIDO

<b>71-5971 - 00 - 00</b>	<b>71-5972 - 00 - 00</b>	<b>71-5973 - 00 - 00</b>	<b>71-5974 - 00 - 00</b>	<b>71-5975 - 00 - 00</b>
I	LH	LL	T	X

Profile union kit Kit unión perfil    Kit union L Kit union L    Kit union L Kit union L    Kit union T Kit union T    Kit union X Kit union X



## Taglio di luce 50 mm

□ 14



BODY MAT AL IP20 1 RECOM LED STRIPS On HP / On PL / On SP

**TRIMLESS**  
SIN MARCO

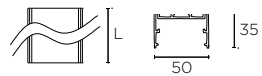

L	
1000 mm	71-5753
2000 mm	71-5754 - 14 - 00
3000 mm	71-5755

**TRIMLESS** NOT INCLUDED / REQUIRED  
SIN MARCO NO INCLUIDO / REQUERIDO



71-5770 - 14 - 00

End cap / 2 units/ref  
Tapa final / 2 unidades/ref



71-5788 - 00 - 00

Recessed kit 1000mm  
Kit para empotrar 1000mm

**TRIMLESS** NOT INCLUDED / REQUIRED  
SIN MARCO NO INCLUIDO / REQUERIDO



L	
1000 mm	71-5779
2000 mm	71-5780 - 00 - 00
3000 mm	71-5781
10000 mm	71-5486



Tinted diffuser  
Difusor Opal

**TRIMLESS** NOT INCLUDED  
SIN MARCO NO INCLUIDO



71-5782 - 00 - 00    71-5983 - 00 - 00    71-5784 - 00 - 00    71-5785 - 00 - 00    71-5757 - 00 - 00    71-5758 - 00 - 00

**I** Profile union kit  
Kit unión perfil  
**LH** Kit union L  
Kit union L  
**T** Kit union T  
Kit union T  
**X** Kit union X  
Kit union X  
**LVU** Kit union L  
Kit union L  
**LVD** Kit union L  
Kit union L

## Taglio di luce Indirect

SURFACE  
SUPERFICIE

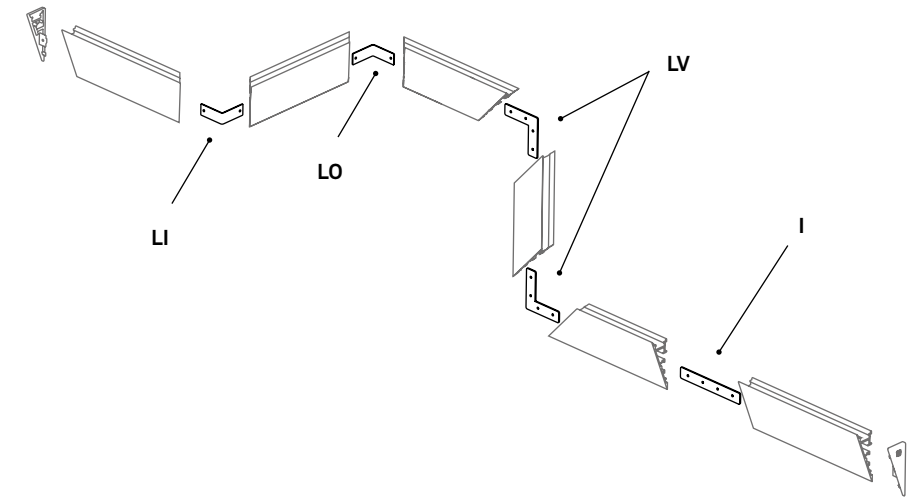

RECESSED  
EMPOTRADO

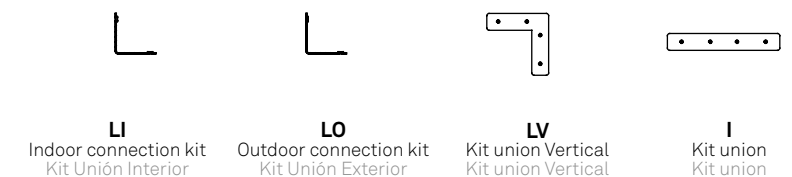
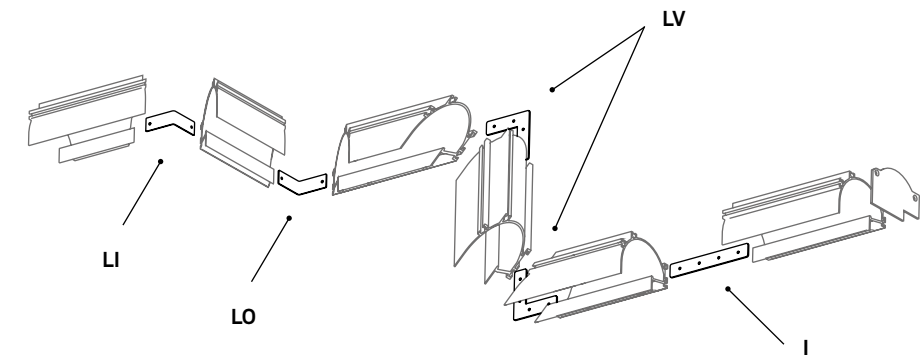

# Taglio di luce Indirect

□ 14



BODY MAT AL IP20 RECOM LED STRIPS On HP / On PL / On SP

## SURFACE SUPERFICIE



L	
1000 mm	<b>71-5759</b>
2000 mm	<b>71-5760 - 14 - 00</b>
3000 mm	<b>71-5761</b>

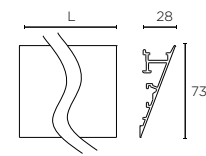

## RECESSED EMPOTRADO



L	
1000 mm	<b>71-5762</b>
2000 mm	<b>71-5763 - 14 - 00</b>
3000 mm	<b>71-5764</b>

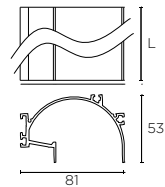

## SURFACE NOT INCLUDED / REQUIRED SUPERFICIE NO INCLUIDO / REQUERIDO



**71-5608 - 14 - 00**

End cap / 2 units/ref  
Tapa final / 2 unidades/ref



**71-5756 - 14 - 00**

Wall mount kit / 3 units/ref  
Kit fijación perfil / 3 unidades/ref

## SURFACE NOT INCLUDED / REQUIRED EMPOTRADO NO INCLUIDO / REQUERIDO



**71-5609 - 14 - 00**

End cap / 2 units/ref  
Tapa final / 2 unidades/ref



**71-5789 - 00 - 00**

Recessed kit 1000mm  
Kit para empotrar 1000mm

## SURFACE & RECESSED NOT INCLUDED / REQUIRED SUPERFICIE & EMPOTRADO NO INCLUIDO



L	
1000 mm	<b>71-5771</b>
2000 mm	<b>71-5772 - 00 - 00</b>
3000 mm	<b>71-5773</b>
10000 mm	<b>71-5774</b>

DIF.MAT PC  
Tinted diffuser  
Difusor Opal

## SURFACE & RECESSED NOT INCLUDED SUPERFICIE & EMPOTRADO NO INCLUIDO



**71-5782 - 00 - 00**

I

Profile union kit  
Kit unión perfil



**71-5783 - 00 - 00**

LV

Vertical  
Vertical  
Kit union L  
Kit union L



**71-5757 - 00 - 00**

LO

Kit union L  
Kit union L



**71-5758 - 00 - 00**

LI

Kit union L  
Kit union L

# On HP

IP20 100 3 MacAdam 120° 50000h L70 B30 BASIC SOLUTION COMPATIBLE WITH LINEAL P. 250 RECOM TAGLIO DI LUCE

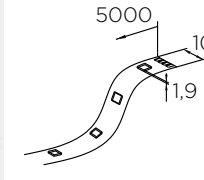

LED					
K	CRI	W	Real lm	W/1m	
2500	80	48	3334	9,6	<b>91-3282 - 00 - 00</b>
2700	80	48	4110	9,6	<b>91-5565 - 00 - 00</b>
3000	80	48	4110	9,6	<b>91-2361 - 00 - 00</b>
4000	80	48	4110	9,6	<b>91-5566 - 00 - 00</b>

5m

P. 213 24VDC DIM

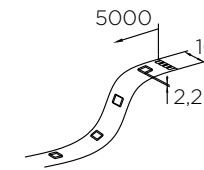

LED					
K	CRI	W	Real lm	W/1m	
RGB	80	72	272	14,4	<b>91-2379 - 00 - 00</b>

5m

P. 213 24VDC DIM

# On PL

IP20 40 3 MacAdam 120° 5m 50000h L70 B30 COMPATIBLE WITH LINEAL P. 250 RECOM TAGLIO DI LUCE

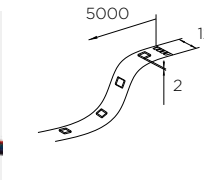
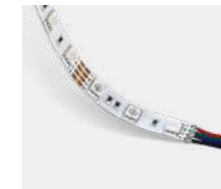

LED					
K	CRI	W	Real lm	W/1m	
2700	80	96	8380	19,2	<b>91-5568 - 00 - 00</b>
3000	80	96	8380	19,2	<b>91-5569 - 00 - 00</b>
4000	80	96	8380	19,2	<b>91-5570 - 00 - 00</b>

P. 213 24VDC DIM

# On SP

IP20 40 3 MacAdam 120° 5m 50000h L70 B30 COMPATIBLE WITH LINEAL P. 250 RECOM TAGLIO DI LUCE

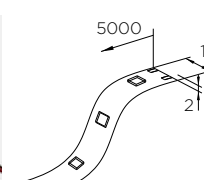

LED					
K	CRI	W	Real lm	W/1m	
2700	80	144	13410	28,8	<b>91-5571 - 00 - 00</b>
3000	80	144	13410	28,8	<b>91-5572 - 00 - 00</b>
4000	80	144	13410	28,8	<b>91-5573 - 00 - 00</b>

P. 213 24VDC DIM

# Maai

□ 14



BODY MAT PC DIF MAT PMMA IP20 20 50000h L70 B30 3 MacAdam 350° CONTROL

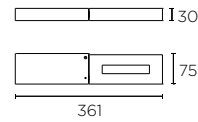

LED SAMSUNG						
L	K	CRI	W	Real lm	W/1m	
1mt	3000	80	11,6	851	05-6399 - 14	OU
						DU
1mt	3000	80	24,5	1644	05-6408 - 14	OU
						DS
1mt	3000	80	11,6	851	05-6405 - 14	OU
						DU
1mt	3000	80	24,5	1644	05-6411 - 14	OU
						DS

OU ON/OFF 100-240V 50-60Hz  
 DU DALI 100-240V 50-60Hz  
 DS DALI 220-240V 50-60Hz

## Photometric data / Fotometría

LED CRI80 3000K 11,6W

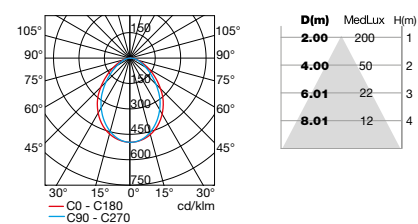

LED CRI80 3000K 24,5W

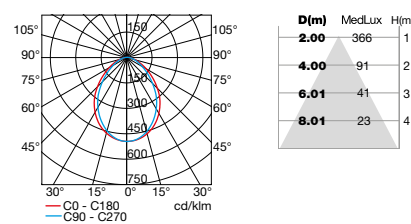

# Asai Side Bend

N

BODY MAT PUR IP67 IK10 10 50000h L70 B30 3 MacAdam 19,8 UGR 120° 8m CONTROL

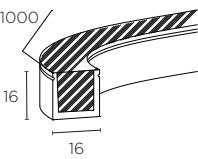
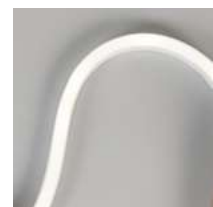

LED						
L	K	CRI	W	Real lm	W/1m	
1mt	3000	80	14,4	441	14,4	91-6607 - 00 - 00
						P. 213 24VDC
8mt	3000	80	115,2	3529	14,4	91-6608 - 00 - 00
						P. 213 24VDC

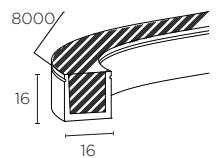

# Asai Top Bend

N

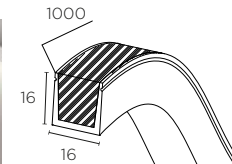

LED						
L	K	CRI	W	Real lm	W/1m	
1mt	3000	80	14,4	441	14,4	91-6609 - 00 - 00
						P. 213 24VDC

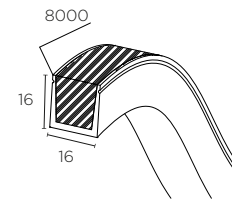

LED						
L	K	CRI	W	Real lm	W/1m	
8mt	3000	80	115,2	3529	14,4	91-6610 - 00 - 00
						P. 213 24VDC

## Not included / No incluido

71-6607 - 00 - 00

50

20 clips x 3cm  
20 clips x 3cm

71-6608 - 00 - 00

20

2 m rigid profile  
Perfil 2mts rígido

71-7698 - 00 - 00

10

2 m flexible profile  
Perfil 2 mts flexible

## Photometric data / Fotometría

LED CRI80 3000K 14,4W (91-6609)

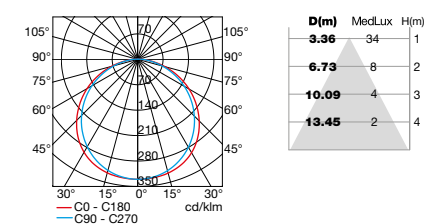

## Drivers



LxWxH mm	IP CLASS	V in	Frequency / Frecuencia	V out	Exit current / Corriente de Salida		Current (mA) / Corriente (mA)	W min	W max	Power factor / Factor de potencia	Phase cut - Dimming / Corte de fase - Dimmable	Push	0-10v	1-10v	DALI		
					min	max											
124 x 79 x 22	20	110-240	50-60 Hz	0-74	350	1050	-	0	50.00	0.95	-	-	-	-	-	-	<b>71-3542-00-00</b>
110 x 52 x 22	20	110-240	50-60 Hz	2-43	250	700	-	0.70	20.00	0.92	-	-	-	-	x	-	<b>71-6192-00-00</b>
123 x 45 x 19	20	100-240	50-60 Hz	23-46	-	-	350	8.00	16.10	0.82	-	-	-	-	-	-	<b>71-6652-00-00</b>
123 x 45 x 19	20	100-240	50-60 Hz	5-13	-	-	700	3.50	9.10	0.78	-	-	-	-	-	-	<b>71-6651-00-00</b>
80 x 37 x 21	20	220-240	50-60 Hz	9-29	-	-	350	3.00	11.00	0.90	x	-	-	-	-	-	<b>71-7709-00-00</b>
110 x 52 x 22	20	100-240	50-60 Hz	2-43	350	900	-	2.00	20.00	0.95	-	x	x	x	-	-	<b>71-7710-00-00</b>
68 x 33 x 22	20	100-277	50-60 Hz	8-13	-	-	350	2.80	4.00	0.40	-	-	-	-	-	-	<b>71-7364-00-00</b>
95 x 53 x 25	20	220-240	50-60 Hz	18-38	-	-	350	6.30	13.00	0.95	x	-	-	-	-	-	<b>71-5272-00-00</b>
115 x 45 x 29	20	100-240	50-60 Hz	21-42	-	-	500	10.50	21.00	0.82	-	-	-	-	-	-	<b>71-7551-00-00</b>
95 x 53 x 30	20	220-240	50-60 Hz	18-36	-	-	500	9.00	18.00	0.95	x	-	-	-	-	-	<b>71-7711-00-00</b>
102 x 38 x 21	20	220-240	50-60 Hz	6-14	-	-	700	4,2	10.00	0.96	x	-	-	-	-	-	<b>71-7663-00-00</b>

## IP67 Driver & Connector



W	mA	
10	700	<b>71-E014 - 24 - 24</b>
20	700	<b>71-E015 - 24 - 24</b>
20	500	<b>71-E068 - 24 - 24</b>



Not Included / No Includo	Ⓢ	Push	1-10v	DALI	
	m				
	1,5	X	X	X	<b>71-3476-00-00</b>
	4	X	X	X	<b>71-4707-00-00</b>

Included / Includo



Cable for synchronising  
Cable para sincronización

Electrical units / Unidades eléctricas

## Power supply / Fuente de Alimentación



LxWxH mm	IP CLASS	V in	Frequency / Frecuencia	Ⓢ	V out	Exit current / Corriente de Salida	W min	W max	Power factor / Factor de potencia	
167 x 38 x 29	20	100 - 240	47 - 63Hz	X	12	DC	-	20	>0.9	<b>71-5489-00-00</b>
270 x 40 x 23	67	120 - 277	47 - 63Hz	X	12	DC	10	100	>0.9	<b>71-3479-00-00</b>
300 x 44 x 23	20	120 - 277	47 - 63Hz	X	24	DC	10	96	>0.9	<b>71-5487-00-00</b>
220 x 40 x 21	20	100 - 277	50 - 60Hz	X	24	DC	3,5	35	>0.95	<b>71-6339-00-00</b>
250 x 40 x 21	20	100 - 277	50 - 60Hz	X	24	DC	4,8	60	>0.95	<b>71-6340-00-00</b>
202 x 71,2 x 45	67	100 - 240	50 - 60Hz	X	24	DC	0	100	>0.97	<b>71-6341-00-00</b>
225 x 60 x 36	20	220 - 240	50 - 60Hz	X	24	DC	0	70	>0.97	<b>71-6342-00-00</b>
240 x 60 x 49	20	220 - 240	50 - 60Hz	X	24	DC	0	150	>0.98	<b>71-6343-00-00</b>
244 x 71,2 x 45	67	100 - 240	50 - 60Hz	X	24	DC	0	150	>0.95	<b>71-6344-00-00</b>
244 x 71 x 37,5	67	100 - 305	50 - 60Hz	X	24	DC	0	240	>0.97	<b>71-6345-00-00</b>
252 x 90 x 43,8	67	100 - 305	50 - 60Hz	X	24	DC	0	320	>0.98	<b>71-6346-00-00</b>

(ENG) Nowadays, lighting no longer has an exclusively functional use. It is seen from a wider perspective, as something that can be used to manage spaces and create atmospheres. This is why LEDES C4 conceptualises and develops lighting projects that can adapt a space to various uses and meet needs that go beyond lighting, such as comfort and well-being and all in an easy, quick and simple way. From control of a light source to complete management of a space: LEDES C4 provides its customers with complete lighting solutions that combine lighting and control to ensure greater 1-10V, DALI, DMX, Bluetooth interoperability. And all with support from technological partners specialising in each sector: restaurants, offices, meeting rooms, hotel rooms...

(ESP) Actualmente la iluminación deja de tener un uso exclusivamente funcional, y pasa a trabajar desde una perspectiva más amplia, gestionando los espacios y creando atmósferas. Así, LEDES C4 conceptualiza y desarrolla proyectos lumínicos con el fin de adaptar un espacio a varios usos y dar respuesta a las necesidades no solamente lumínicas, sino también de bienestar y confort, de una forma fácil, rápida y sencilla. Desde el control de un punto de luz hasta la gestión completa de un espacio: LEDES C4 pone en manos de sus clientes una solución completa de iluminación que aúna las luminarias y el control, basada en estándares de control para conseguir la mejor interoperabilidad, 1-10V, DALI, DMX, Bluetooth. Y todo ello rodeada de los partners tecnológicos más especializados en cada área: restaurantes, oficinas y salas de reuniones, habitaciones de hotel...

### Connected lighting / Iluminación conectada

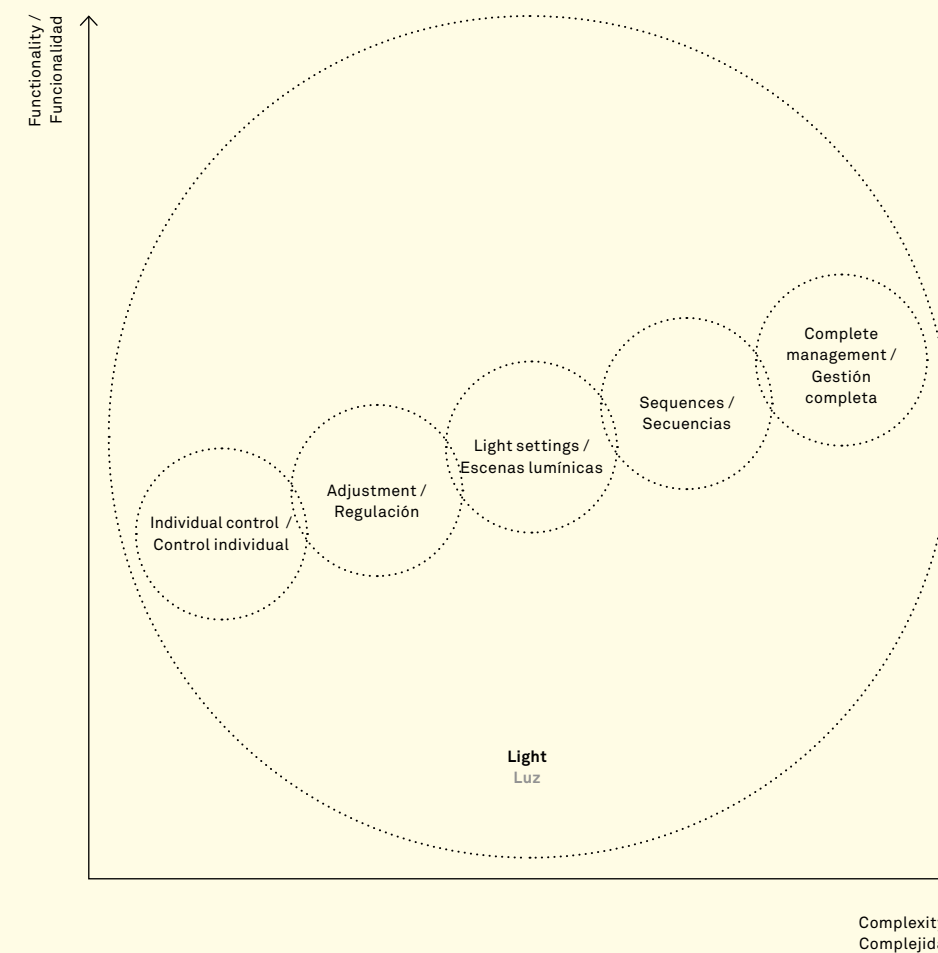

## Lighting Control / Soluciones de Control de Iluminación

(ENG) Enables one or several rows of luminaires to be controlled in a particular place to adapt lighting to individual requirements, moods and times of day, while also saving energy.

(ESP) Permiten adecuar la iluminación de una o varias líneas de luminarias dentro de un mismo espacio para adaptar la luz a las necesidades de las personas, su estado de ánimo y el momento del día, consiguiendo a la vez un gran ahorro energético.



### CADENA DE VALOR

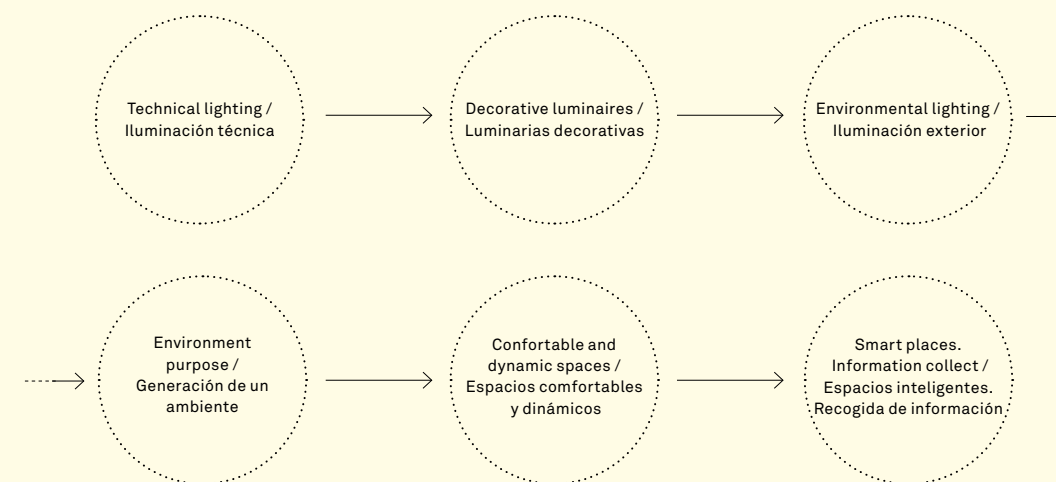

### Example of use / Ejemplo de aplicación

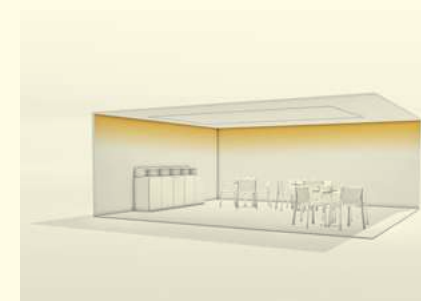

→ ENG. RGB lighting effects create sensations to suit the needs of each moment: transmitting a sense of dynamism or relaxation.

→ ESP. La iluminación de efecto RGB realiza sensaciones dependiendo de las necesidades de cada momento: puede transmitir dinamismo o relajación.

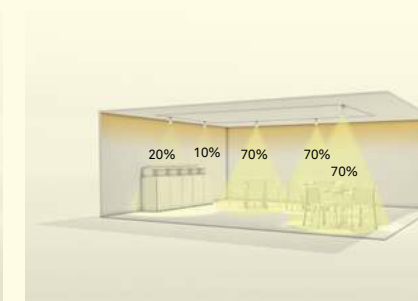

→ ENG. Settings with different lighting levels create the right atmosphere for each moment of the day: lunch (general light), evening meal (soft, focused lighting), etc.

→ ESP. Las escenas con diferentes niveles de iluminación generan la atmosfera adecuada al momento del día: comida (luz general), cena (luz focalizada y tenue), etc

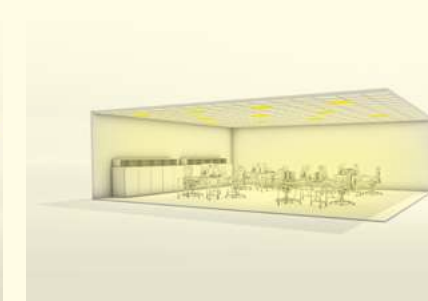

→ ENG. Point-by-point control allows for maximum personalisation of the lighting. It is possible to adapt the level of light for each luminaire to suit the needs at each moment. Using hourly programming prevents lights being used when not necessary. This ensures energy savings.

→ ESP. El control punto a punto permite la máxima personalización de la iluminación. Es posible adaptar el nivel lumínico de cada luminaria a las necesidades de cada momento. Mediante programaciones horarias, se evita que queden luces encendidas cuando no sea necesario. De esta forma, se consigue un ahorro energético.

LEDS C4 S.A.  
Afores s/n 25750 Torà  
Lleida – Spain  
+34 973 468 100  
leds-c4@leds-c4.com

---

## Customer Service

SPAIN + 34 973 468 101 spain@leds-c4.com	GERMANY Toll-free: 0800 188 0989 deutschland@leds-c4.com	EUROPE + 34 973 468 102 europe@leds-c4.com	CANADA Toll-free: + 1-866-5636666 usa@leds-c4.com
UNITED KINGDOM Free-phone: 0808 234 2641 uk@leds-c4.com	ITALY Toll-free: 800 784 275 italia@leds-c4.com	LATIN AMERICA + 34 973 468 115 latinamerica@leds-c4.com	UNITED STATES Toll-free: + 1-888-3710243 usa@leds-c4.com
FRANCE + 34 973 468 130 france@leds-c4.com	PORTUGAL + 34 973 468 130 portugal@leds-c4.com	ASIA PACIFIC - AFRICA + 34 973 468 116 asiapacific@leds-c4.com africa@leds-c4.com	

---

## Madrid

Joaquin Turina,2  
28224 Pozuelo de Alarcón  
MADRID

## Middle East

Fortune Executive Tower – JLT  
PO 336910 – DUBAI – UAE  
+ 971 4458 4272  
middleeast@leds-c4dubai.com

## Asia Pacific

8 Robinson Road,  
#03-00 ASO Building  
048544 SINGAPORE  
+65 8133 5024

## South Africa

Office 114, Regus Business Centre  
(AMR Building)  
3 Concorde Road East  
20007 Bedfordview SOUTH AFRICA  
+27 100 075 231  
+27 844 595 025

---

## Germany

im Wissenschaftspark  
Deutschland GmbH  
Munscheidstraße 14  
45886 Gelsenkirchen  
+49 209 2755 1228  
deutschland@leds-c4.com

## Poland

ul.Nektarowa 11B 52-210.  
Wroclaw POLAND  
+ 48 71 733 64 01  
biuro@leds-c4.pl

---

## Press

+ 34 973 468 117  
comunicacion@leds-c4.com

## Suppliers

+ 34 973 468 113  
compras@leds-c4.com

---

leds-c4.com

facebook.com/ledsc4.sa  
twitter.com/ledsc4  
instagram.com/leds\_c4/  
pinterest.com/ledsc4/  
linkedin.com/company/leds-c4

Edition: LEDS C4 The interiors collection 2019

Special Thanks:

Art Direction and Design: Querida  
Still Life Photography: Marçal Vaquer  
In Place Photography: Salva López  
Spatial design: Atelier Ramos  
CGI: Visualizers

Almanac Barcelona Hotel  
Margot House  
Casa Bonay  
Three Marks Coffee

Printing: Nova Era Publications

DIALux



